

EYE INSTRUMENTS

ABOUT US

Medmal is a leading manufacturer of high-quality eye instruments, specializing in precision tools for ophthalmic diagnostics and surgery. Known for innovation and reliability, our products support healthcare professionals in delivering the best vision care and outcomes.

Ophthalmic Instruments

Table of Contents

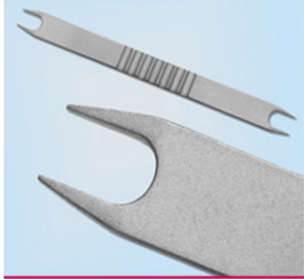

Calipers

4

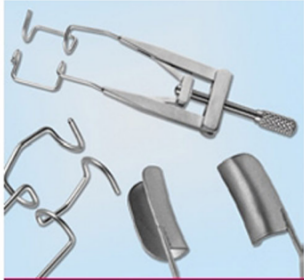

Speculums

5 - 7



Retractors

7 - 9



Depressors

9

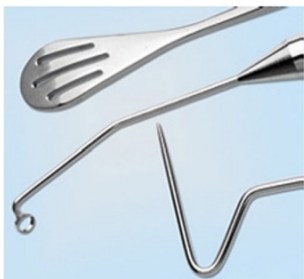

Hooks/Manipulators

10 - 22



Fixation Rings/Markers

23 - 25

Scissors

25 - 36

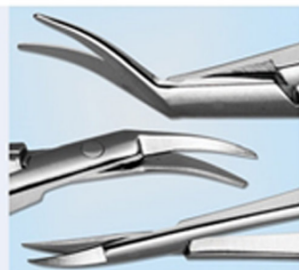

Forceps

36 - 44



Needle Holders

45 - 48



Dilator/Lacrimal Probes

47 - 48

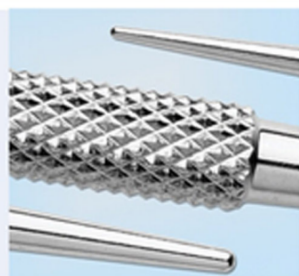

Cannulas

49 - 56

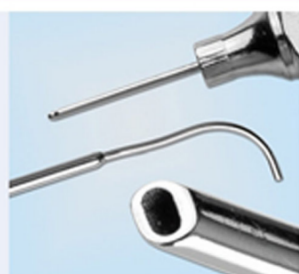

Miscellaneous

57



INCHES

Ophthalmic Instruments

Table of Contents

CHOPPERS

58

SPATULAS

59

DOUBLE SIDED INSTRUMENTS

60

GAUGES

61

CURETTES

62

RETRACTORS

63

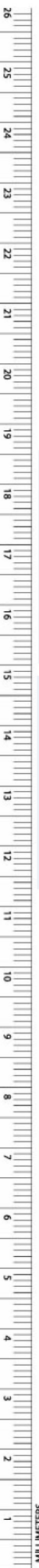

Ophthalmic Instruments

Calipers

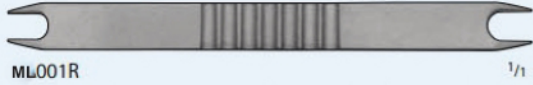

ML001R

1/16

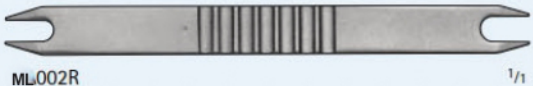

ML002R

1/16

BRAUNSTEIN Calipers

ML001R

3.5/4.0 mm, 2³/₄"

ML002R

3.0/3.5 mm, 2³/₄"

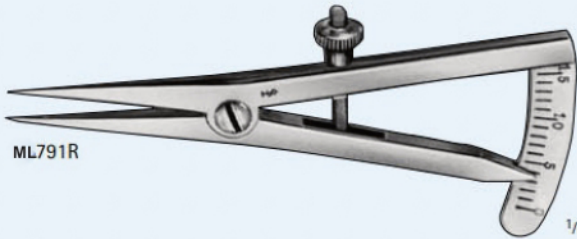

ML791R

1/16

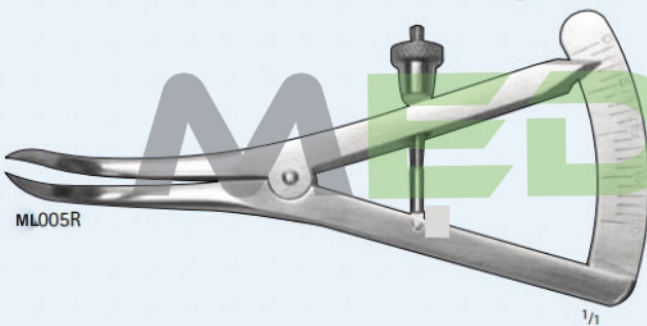

ML005R

1/16

CASTROVIEJO Eye Calipers

ML791R

Straight, Range 0-15 mm, 3¹/₈"

ML005R

Curved, Range 0-20 mm, 3¹/₈"

BARRAQUER Eye Speculums

ML751R

10 mm Blades, 1 1/2"

ML200R

14 mm Blades, 1 3/4"

ML752R

Heavy Wire, 14 mm, 1 3/4"

ML754R

15 mm Solid Blades, 1 3/4"

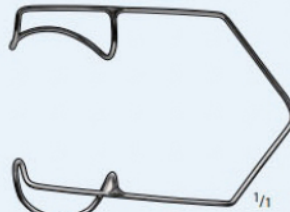

ML751R



ML752R

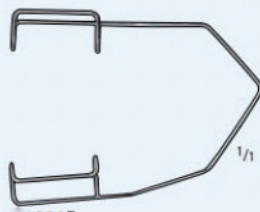

ML200R

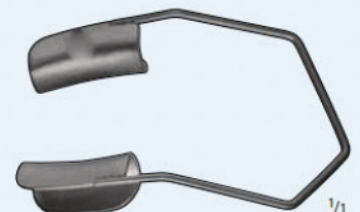

ML754R

KRATZ-BARRAQUER Eye Speculums

ML756R

Pediatric, 10 mm, 1 3/8"

ML755R

14 mm Blades, 1 1/2"

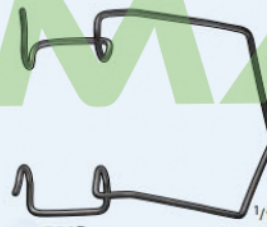

ML756R

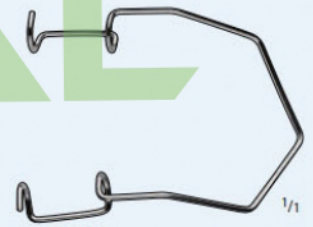

ML755R

ALPHONSO Infant Speculum

ML757R

5 mm & 9 mm wide x 7mm deep Blades, 1 3/4"

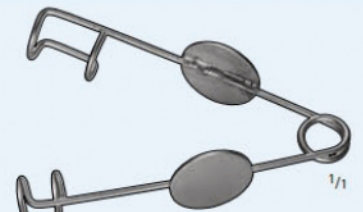

ML757R

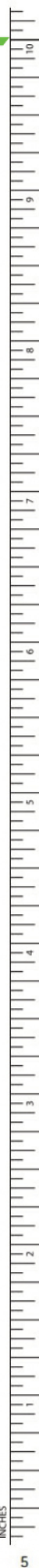

Ophthalmic Instruments

Speculums

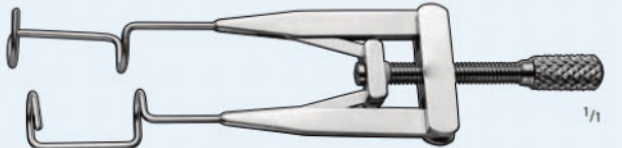

ML750R

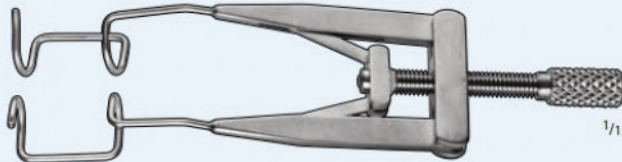

ML758R

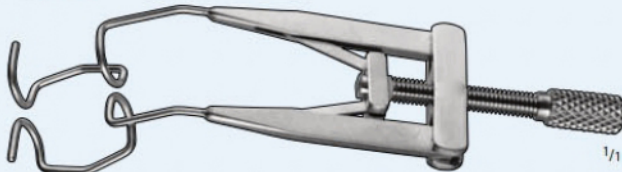

ML759R

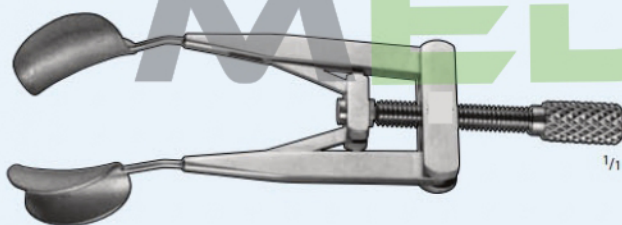

ML760R

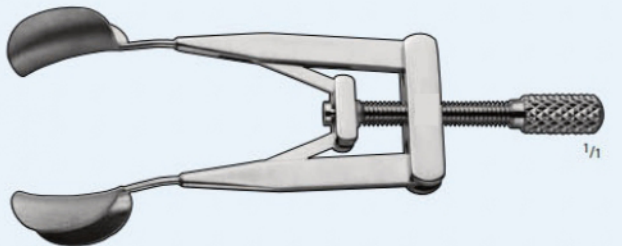

ML764R

LIEBERMAN Adjustable Speculums

ML750R

Straight, 16 mm Square Wire Blades, 3 1/8"

ML758R

Angled, 14 mm Square Wire Blades, 3 1/4" Length

ML759R

Angled, 14 mm V-Shaped Wire Blades, 3 1/4" Length

ML760R

Angled, 14 mm Solid Blades, 3 1/4" Length

ML764R

Reversible, Angled, 14 mm Solid Blades, 3 1/8"



ML762R



ML763R

JAFFE Wire Lid Retractors

ML762R

15 mm Blades, Pair, 1 1/2"

ML763R

13 mm Blades, Pair, 1 1/2"

Speculums

SAUER Eye Speculums

OA218R

11 mm Blades, 1 3/8"

ML

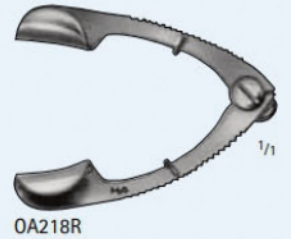

LANCASTER Eye Speculum

ML225R

15 mm Wide, x 7 mm Deep, 3 1/8"

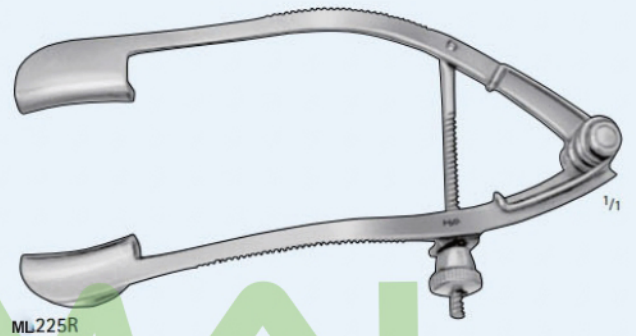

MEDMAL

Retractors

DESMARRES Lid Retractors

ML310R

9 x 9 mm, 5 1/2"



ML311R

9 x 12 mm, 5 1/2"



ML310R



ML311R



ML312R

ML312R

11 x 14 mm, 5 1/2"

ML313R

12 x 16 mm, 5 1/2"



ML313R



ML314R

ML314R

13 x 18 mm, 5 1/2"

Ophthalmic Instruments

Retractors

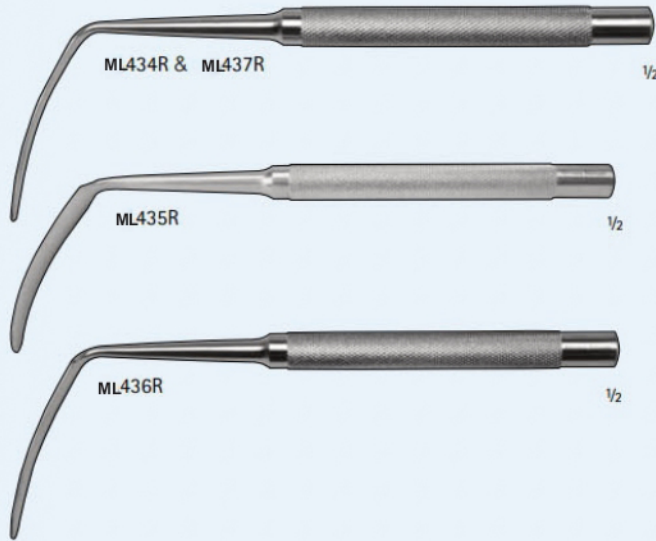

SEWALL Orbital Retractors

ML434R

7 x 52 mm Blade, 6 $\frac{3}{4}$ "

ML435R

9 x 44 mm Blade, 6 $\frac{3}{8}$ "

ML436R

11 x 50 mm Blade, 6 $\frac{3}{8}$ "

ML437R

13 x 67 mm Blade, 6 $\frac{3}{4}$ "



SCHEPENS Orbital Retractor

ML749R

Smooth, 14 x 61 Blade, 6 $\frac{1}{8}$ "



JAEGER Lid Plate

ML765

Clear Plastic, 20 mm / 23 mm Wide, 3 $\frac{3}{4}$ "



BERKE-JAEGER Lid Plate

MA766R

20 mm / 30 mm Wide, 4 $\frac{1}{4}$ "



WELLS Enucleation Spoon

MA731R

21 mm Diameter, 5 $\frac{3}{4}$ "

BUNGE Evisceration Spoons

ML744R
Small, 8 mm Diameter, 5 1/4"

ML745R
Large, 12 mm Diameter, 5 1/2"

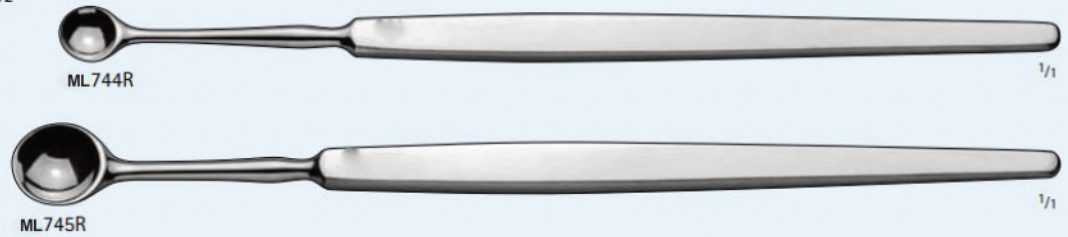

MEDMAL Depressors

SCHOCKET Scleral Depressor

ML761R
Double Ended, with Pocket Clip, 5 1/4"



FLYNN Scleral Depressor

ML747R
5 mm Diameter Loop, 3 1/8"

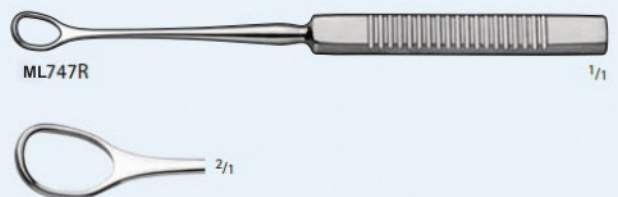

Ophthalmic Instruments

Hooks/Manipulators

WHITMAN SHEPHERD Capsule Polisher

ML777R

Double Ended, Left Angled, Right Angled, 5 1/8"



KOCH Stop and Chop Manipulator

ML778R

Angled Shaft with 1.5 mm Tip, 4 3/4"

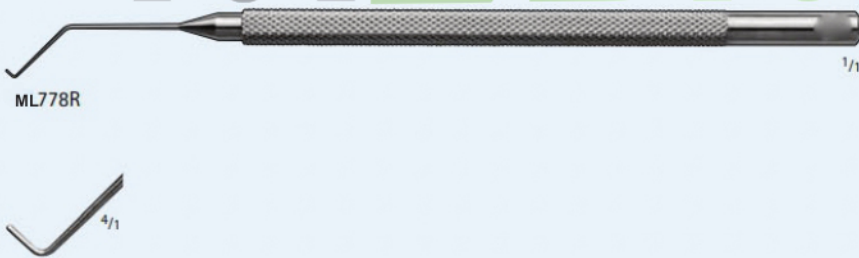

CAMELLIN-style LASEK Alcohol Well

ML779R

8.5 mm Diameter, 4 1/2"



SLOANE LASEK Spatulas

ML780R
Micro Hoe, Semicircular Tip, Beveled Edge, 4 1/2"

ML781R
Epi Peeler, Semi Sharp, 4 1/2"

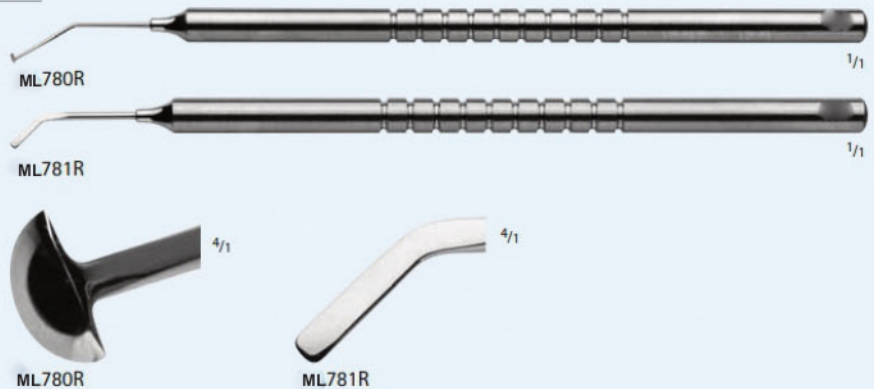

CHANG-SEIBEL Phaco Chopper

ML782R
Double Ended, Angled, C-Shaped Blunt Chopper and Vertical Safety Chopper, for Lefthand, 5 1/2"

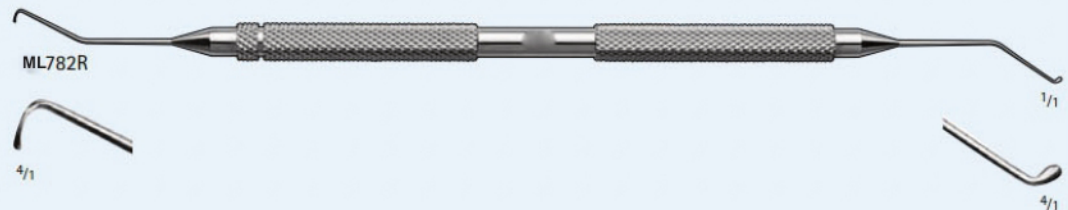

KOCH Nucleus Spatula

ML783R
Gently Curved with 1 mm wide Duckbill Tip, Smooth, 4 1/2"

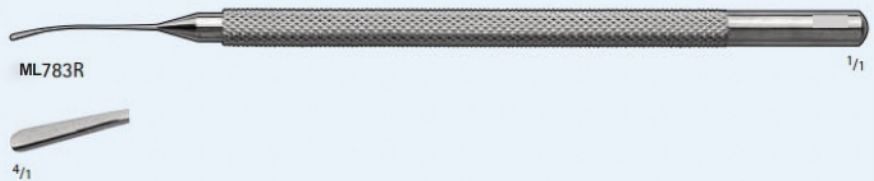

LIEBERMAN Nucleus Manipulator

ML784R
Angled, for Lefthand, 4 1/2"

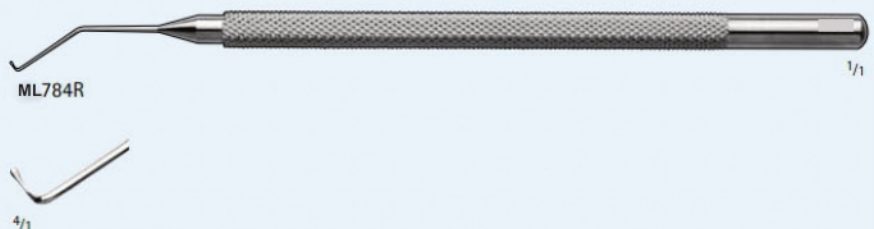

Ophthalmic Instruments

Hooks/Manipulators

CHANG Combo Phaco Chopper

ML785R

Double Ended, Angled, C-Shaped Blunt Chopper and 1.3 mm Sharp "Quick Chop" Tip, for Lefthand, 5¼"



NAGAHARA Nucleus Spatula

ML786R

Angled, Flat Interior Edge, for Lefthand, 4¼"



BECHERT Nucleus Rotator

ML789R

Angled 7 mm from Tip, "Y" Shaped Tip, 4¾"

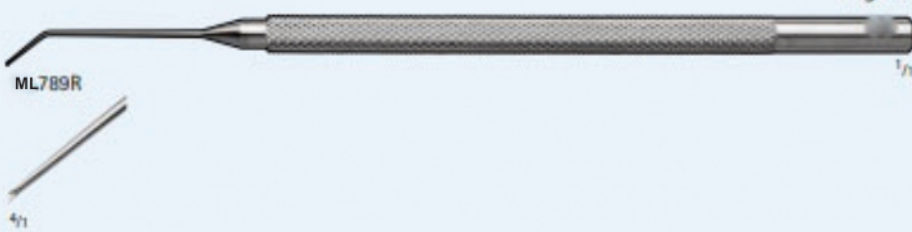

JAFFE-BECHERT Nucleus Rotator

ML790R

Angled 9 mm from Tip, "Y" Shaped Tip, 4¾"



DRYSDALE Nucleus Manipulator

ML791R
Paddle-shaped Tip, 4 1/4"

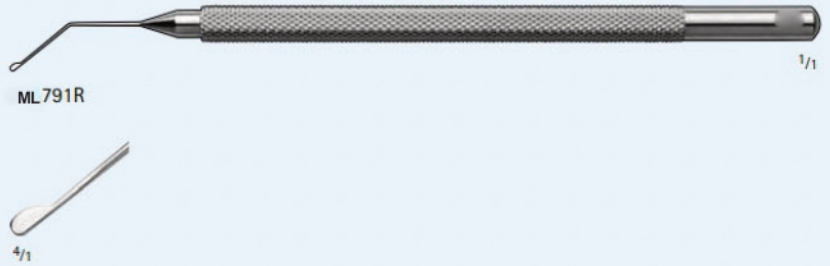

PISACANO Nucleus Rotator

ML792R
Vertical Flat Tip, 4 1/4"

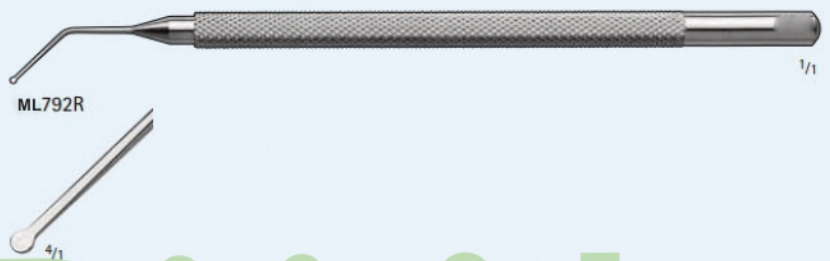

ANIS Wand Nucleus Manipulator

ML793R
Straight, 0.5 mm Ball-Shaped Tip, 4 3/4"

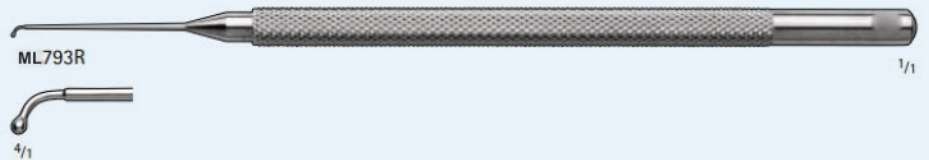

SIEBEL Flap Lifter and Spatula

ML794R
Double Ended, "Z"-Shaped Tip & 1.5 mm Angled Point, 4 1/8"



JAFFE Lens Spatula

ML795R
Flat, 0.5 mm wide Tip, 4 3/4"



Ophthalmic Instruments

Hooks/Manipulators

LESTER IOL Manipulator

ML776R

Straight, 0.25 mm Teardrop Shaped Tip, 4½"

ML796R

Angled, 0.25 mm Teardrop Shaped Tip, 4½"



ML776R

1/1



4/1



ML796R

1/1



4/1



LESTER II IOL Manipulator

ML822T

Angled, 0.2 mm Teardrop Shaped Tip, Titanium, 4½"



ML822R

1/1



4/1

MALONEY IOL Manipulator

ML797R

Curved, 0.25 mm Teardrop Shaped Tip, 4½"



ML797R

1/1



4/1

BARRAQUER Cyclodialysis Spatula

ML637R

0.5 x 15 mm, Angled Blade, 4⁷/₈"



CASTROVIEJO Cyclodialysis Spatula

ML799R

Double Ended, 10 x 0.5 mm Wide and
15 x 0.5 mm Wide, 5¹/₈"

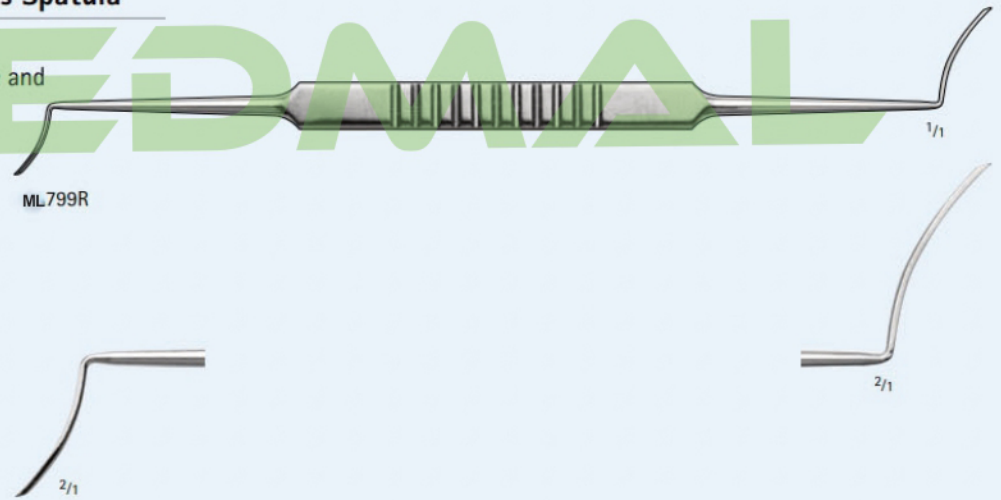

CASTROVIEJO Synechia Spatula

ML798R

Double Ended, 0.5 mm Wide, 5¹/₄"

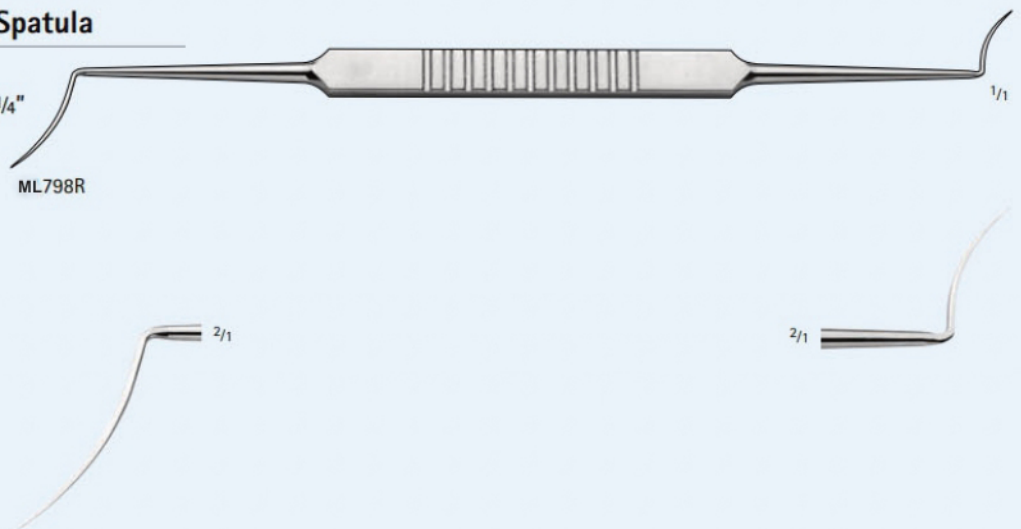

Hooks/Manipulators

PATON Spatula and Spoon

ML801R

Double Ended, 6 mm wide Grooved Spoon and 1.5 mm Flat Blade Angled at 8 mm, 5 1/2"



GRAETHER Collar Button

ML803R

Angled 45°, 10 mm from Tip, 4 3/4"

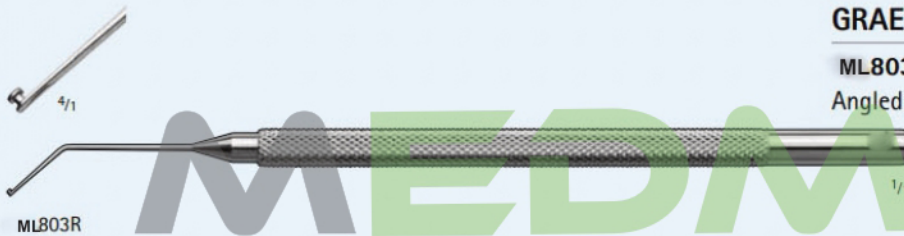

CLAYMAN-JAFFE Lens Hook

ML 805R

Angled, 0.15 mm Blunt Tip, 4 1/2"



HARRS-SINSKEY Lens Manipulating Hook

ML806R

Angled, 0.25 mm Blunt Tip, Flat Handle, 4 1/2"



SINSKEY Lens Manipulating Hooks

ML824R

Modified Curved Shaft, Flat Handle, 0.2 mm, 4½"

ML804R

Angled, 0.2 mm Blunt Tip, Reversed, Flat Handle, 4½"

ML630R

Straight, 0.25 mm Hook, Flat Handle, 4⅝"

ML807R

Straight, 0.25 mm Blunt Tip, Round Handle, 4½"

ML808R

Angled, 0.25 mm Blunt Tip, Round Handle, 4½"

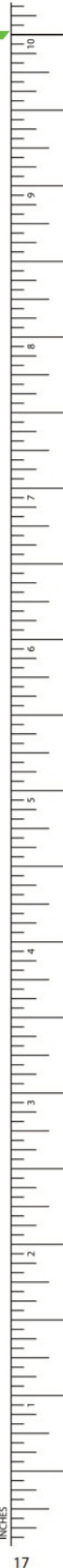
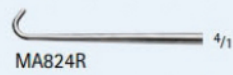

Ophthalmic Instruments

Hooks/Manipulators

SINSKEY II Lens Manipulating Hooks

MA809R

Straight, 0.2 mm Blunt Tip, Flat Handle, 4½"

ML810R

Angled, 0.2 mm Blunt Tip, Flat Handle, 4½"

ML811R

Straight, 0.2 mm Blunt Tip, Round Handle, 4½"

ML812R

Angled, 0.2 mm Blunt Tip, Round Handle, 4½"

ML819T

Angled, 0.2 mm Blunt Tip, Round Handle,
Titanium, 4½"

ML825T

Straight, 0.2 mm Blunt Tip, Flat Handle, Titanium
4½"



ML809R & ML825T

1/1



ML810R

1/1



ML811R

1/1



ML819T

1/1



ML809R & ML825T

4/1

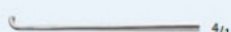

ML811R

4/1

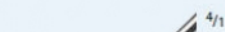

ML810R & ML812R

4/1



ML819T

4/1

MILLIMETERS

KUGLEN Iris Hook and Lens Manipulators

ML631R

0.5 mm "K" Hook, Straight Shaft, 4⁵/₈"

ML813R

Straight, Push-pull Model, Flat Handle, 4¹/₂"

ML814R

Angled, Push-pull Model, Flat Handle, 4¹/₂"

ML815R

Straight, Push-pull Model, Round Handle, 4¹/₂"

ML816R

Angled, Push-pull Model, Round Handle, 4¹/₂"

ML827T

Straight, "K" Hook Model, Round Handle, Titanium, 4¹/₂"

ML826T

Angled, Push-pull Model, Round Handle, Titanium, 4¹/₂"

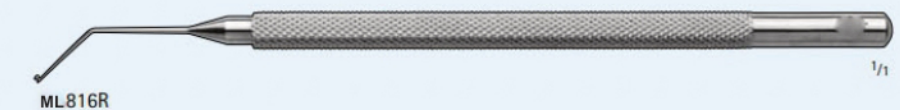
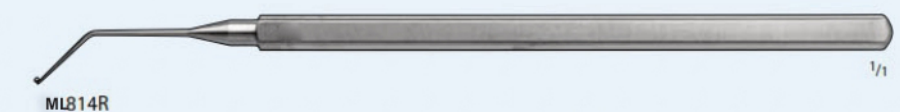
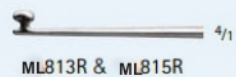

JAMESON Muscle Hooks

ML632R
Small, 5³/₁₆"

ML828R
Large, 1.7 mm Wide Tip, 10 mm, 4³/₄"

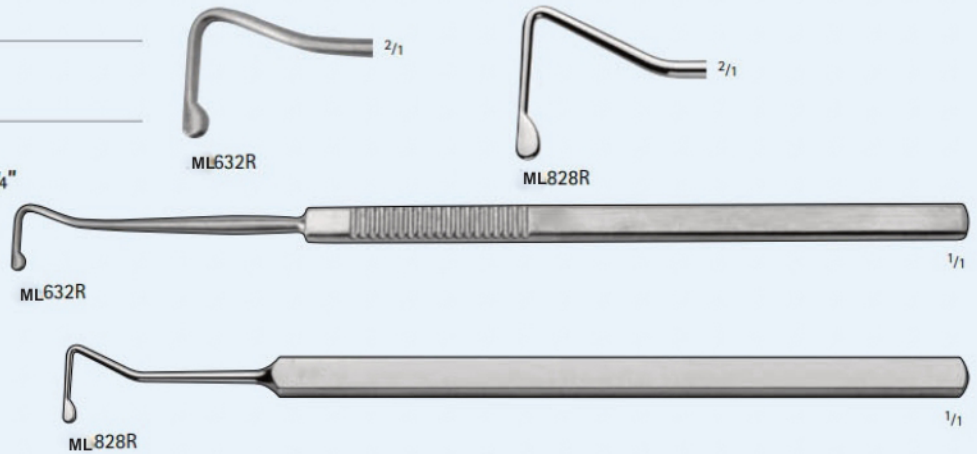

Green Strabismus Hook

ML633R
Flat, 8 mm Wide Hook, 5¹/₈"

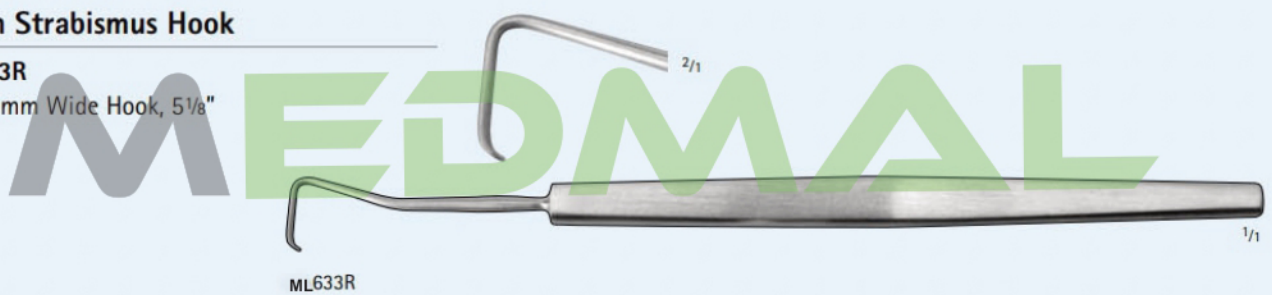

Twist Fixation Hook

ML634R
Right, Clockwise Twist, 4⁵/₁₆"



GASS Retinal Detachment Hook

ML635R
5⁵/₈"



STEVENS Tenotomy Hook

ML636R
5 mm Curved Blunt Hook, 4⁵/₈"



Ophthalmic Instruments

Hooks/Manipulators



ALFONSO Nucleus Trisector

ML 800R

1.5 mm Wide, 4 1/8"

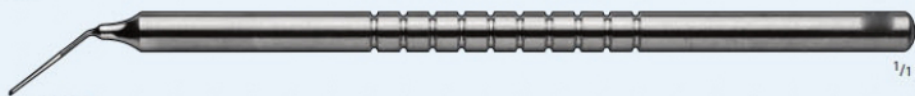

ML800R



PIGTAIL Probes

ML971R

Blunt, 8 mm Diameter Pigtails, 6 1/8"

ML924R

Blunt, 8 mm Diameter Pigtails, Suture Holes, 5 1/8"



ML971R & ML924R



NEW ORLEANS Lens Loop

ML 823R

4 x 10 mm loop, 5 1/2"

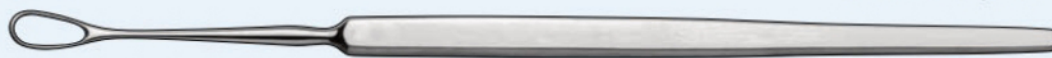

ML823R

FLIERINGA Scleral Fixation Rings

ML732R
12 mm Diameter

ML 733R
13 mm Diameter

ML 734R
14 mm Diameter

ML 735R
15 mm Diameter

ML 736R
16 mm Diameter

ML 737R
17 mm Diameter

ML738R
18 mm Diameter

ML739R
19 mm Diameter

ML740R
20 mm Diameter

ML741R
21 mm Diameter

ML 742R
22 mm Diameter

ML743R
Set of 8, 15-22 mm Diameter



ML732R- ML743R

OSHER-NEUMANN Corneal Marker

ML975R
8 Blade, 4 1/8"



ML975R



2/1

THORNTON Swivel Fixation Ring

ML829R
13 mm Diameter, Blunt Teeth, 4 1/2"



ML829R

Ophthalmic Instruments

Fixation Rings/Markers

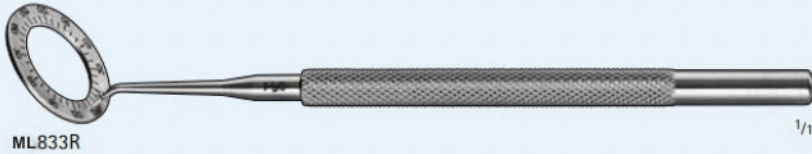

MENDEZ Degree Gauge

ML833R
12 mm ID, Calibrated 100 from 0-1800, 4 1/4"

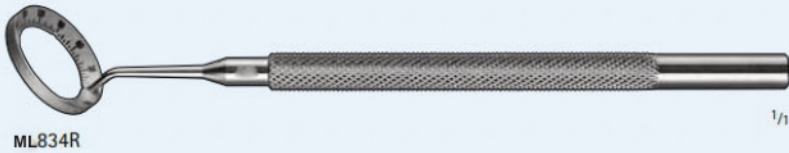

HENDERSON Degree Gauge

ML834R
Beveled Face, Smooth, For Use with MA837R, 4 1/8"



HENDERSON Alignment Marker

ML835R
Blunt Pin Markings at 3, 6, & 9 O'Clock, For Use with MA834R & MA837R, 4"

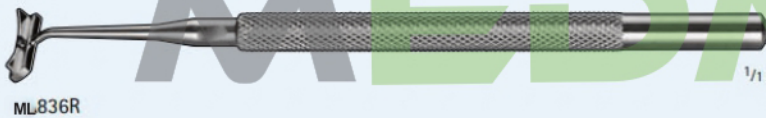

BORES Axis Marker

ML836R
For Use with MA833R, 4"



HENDERSON Toric IOL Marker

ML837R
2.5 mm Axis Marks, for use with MA834R, 4"



BORES Optical Zone Markers

ML838R
3.5 mm ID, 4"

ML839R
6.0 mm ID, 4 1/8"

ML840R
7.0 mm ID, 4 1/8"

ML841R
8.0 mm ID, 4 1/8"



ML838R 2/1

ML839R 2/1

ML840R 2/1

HOFFER Optical Zone Markers

ML842R

4.25 mm ID, 4"

ML843R

5.0 mm ID, 4"

ML844R

5.5 mm ID, 4"

ML845R

6.0 mm ID, 4"

ML846R

8.0 mm ID, 4 1/8"



ML844R - ML846R

1/1



ML842R

2/1



ML843R

2/1



ML844R

2/1



MA846R

2/1

MEDMAL

Scissors

CASTROVIEJO Corneal Section Scissors

ML850R

Right, Angled 9 mm Blade, Blunt Tips, 4 1/4"

ML851R

Left, Angled 9 mm Blade, Blunt Tips, 4 1/4"



ML850R

1/1



2/1



ML851R

1/1



2/1

Ophthalmic Instruments

Scissors



ML847R

TROUTMAN Corneal Scissors

ML847R

Right, 10 mm Blade, 4 1/8"

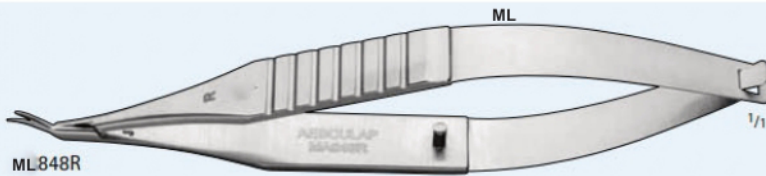

ML848R

CASTROVIEJO Corneal Scissors

ML848R

Curved Right, Small Blade, 4"



ML849R

ML849R

Curved Left, Small Blade, 4"



852R

TROUTMAN-CASTROVIEJO Corneal Scissors

ML852R

Curved Right, Medium Blade, Lock, 4 1/8"



853R

ML853R

Curved Left, Medium Blade, Lock, 4 1/8"



ML854R

TROUTMAN-KATZIN Corneal Scissors

ML854R

Strong Curved Right, Lock, 4 1/8"



ML855R

ML855R

Strong Curved Left, Lock, 4 1/8"

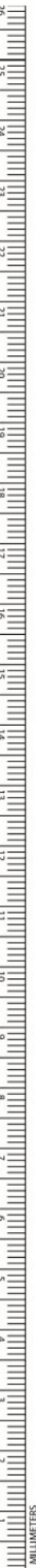

CASTROVIEJO Universal Corneal Scissors

ML858R

Curved Blunt Tips, 16 mm from Mid-Screw, 4³/₄"

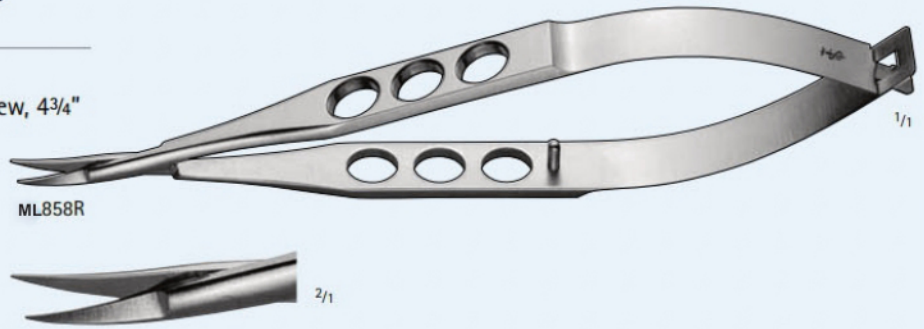

Micro Iris Scissors

ML873R

Curved Sharp Tips, 10 mm from Mid-Screw, 4¹/₈"

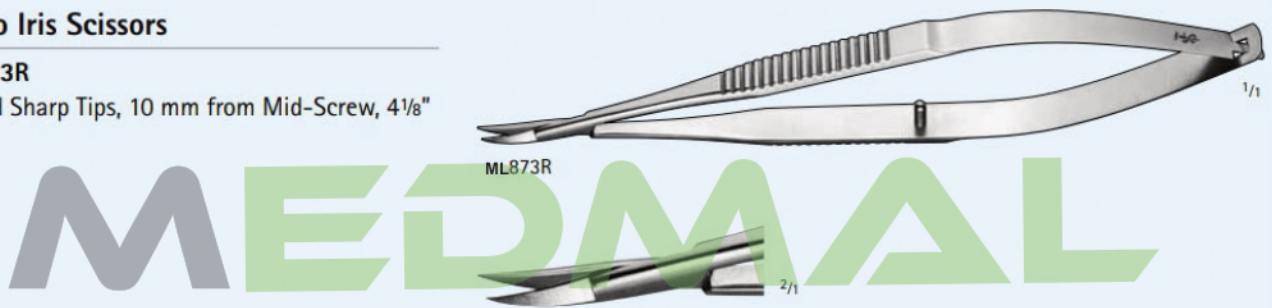

RICH Corneal Scissors

ML856R

Strong Curved Right, X-Delicate, 4¹/₈"

ML857R

Strong Curved Left, X-Delicate, 4¹/₈"

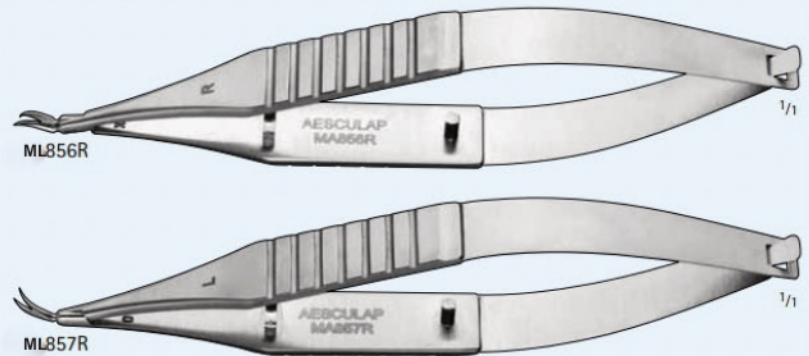

KATZIN Corneal Transplant Scissors

ML859R

Strong Curved Right, Medium Blade, 4¹/₈"

ML860R

Strong Curved Left, Medium Blade, 4¹/₈"

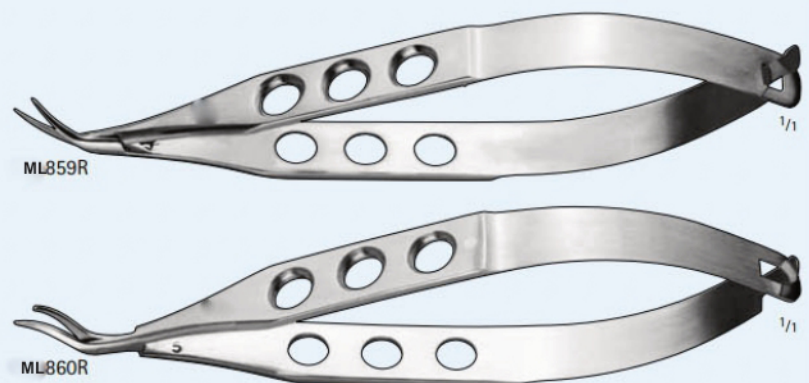

Ophthalmic Instruments

Scissors

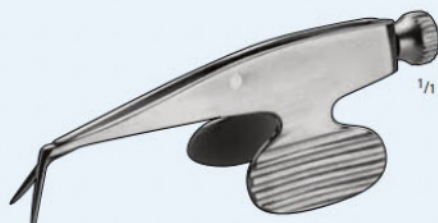

ML861R

BARRAQUER Iris Scissors

ML861R

Blunt, 8 mm Blade, 2 1/4"



ML862R

JAFFE Stitch Scissors

ML862R

X-Sharp, Curved, 4 3/4"



ML864R

FINE Stitch Scissors

ML864R

Sharp, Straight, 5 1/8"



ML865R

VANNAS Scissors

ML865R

Sharp, Curved, 10 mm Blades, 4 3/4"



ML866R

STERN-GILLS Scissors

ML866R

Sharp, X-Delicate, Straight Angled Forward, 10 mm Blades, 4 1/2"

URIBE-STERN Scissors

ML867R

Sharp, X-Delicate, Curved Angled Forward, 10 mm Blades, 4¾"



ML867R

WITHOFF-GILLS Capsulotomy Scissors

ML868R

Blunt, Angled, Curved Tips, 10 mm, 4¾"



ML868R

GILLS-WELSH VANNAS Scissors

ML870R

Sharp, 11 mm Blades, 3¼"

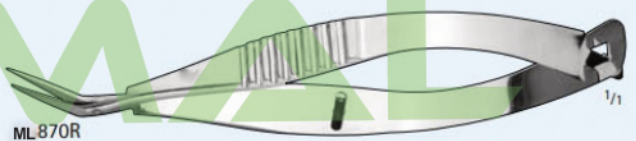

ML870R

DEWECKER Iris Scissors

ML612R

Sharp and Blunt Tips, 4½"



ML612R

VANNAS Capsulotomy Scissors

ML483R

Straight, 3¼"



ML483R

ML484R

Curved, 3¼"



ML484R

ML485R

Angled Down, 3¼"



ML485R

ML486R

Angled Up, 3¼"



MA486R

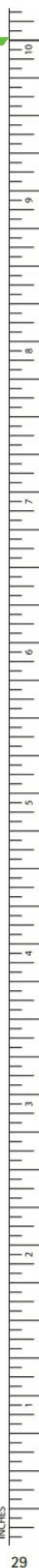

Ophthalmic Instruments

Scissors



ML487R

WESTCOTT Stitch Scissors

ML487R
Sharp Point, 5 1/2"



ML613R

ML613R
Blunt Tips, Right, 4 3/4"



ML614R

ML614R
Blunt Tips, Left, 4 3/4"



ML100R-ML103R

Micro Scissors

ML100R
Round Handle, Straight, Sharp/Sharp, 5 3/4"



ML100R

ML101R
Round Handle, Curved, Sharp/Sharp, 5 3/4"



ML101R

ML103R
Round Handle, Curved, Blunt/Blunt, 5 3/4"

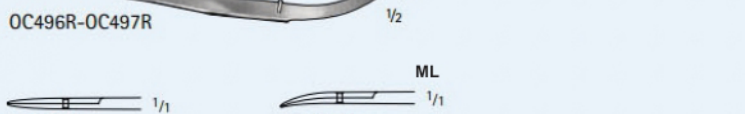

OC496R-OC497R

ML496R
Flat Handle, Straight, 4 1/8"



ML496R

ML497R
Flat Handle, Curved, 4 1/8"



ML020R-ML021R

MILLESI Micro Scissors

ML020R
Flat Handle, Serrated, Straight, 6 1/4"



ML020R

ML021R
Flat Handle, Serrated, Curved, 6 1/4"



ML480R

MCCLURE Micro Scissors

ML480R
Flat Handle, Straight, 3 3/4"



ML482R

NOYES Micro Scissors

ML482R
Flat Handle, Straight, 5"

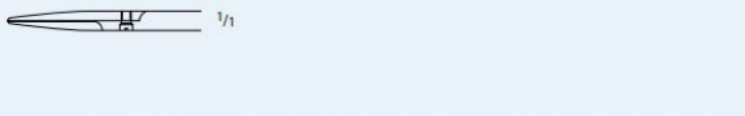

ML482R

CASTROVIEJO Scissors

ML485R

Flat Handle, Lat-Angled, 3³/₄"

ML486R

Flat Handle, Lat-Curved, 3³/₄"

ML491R

Flat Handle, Left-Curved, 4³/₈"

ML492R

Flat Handle, Right-Curved, 4³/₈"

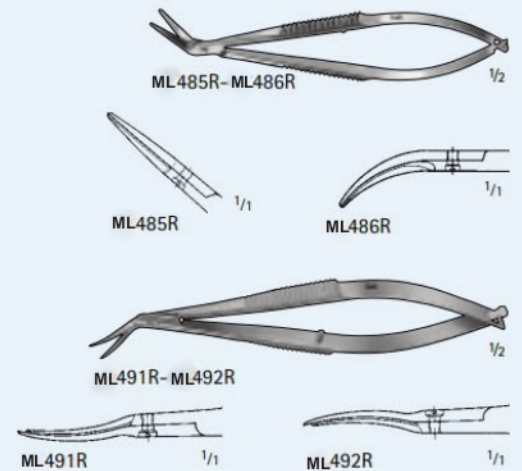

VANNAS Micro Scissors

ML498R

Flat Handle, Straight, 3³/₈"

ML499R

Flat Handle, Curved, 3³/₈"

ML500R

Flat Handle, Angled, 3³/₈"

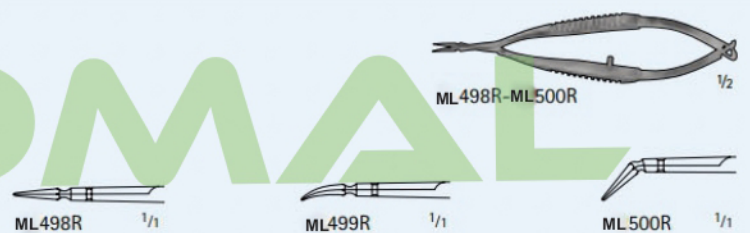

Iris Scissors

ML004R

Square Handle, Straight, Sharp/Sharp, 4¹/₂"

ML005R

Square Handle, Curved, Sharp/Sharp, 4¹/₂"

ML050R

Delicate, Round Handle, Straight, Sharp/Sharp, 4³/₈"

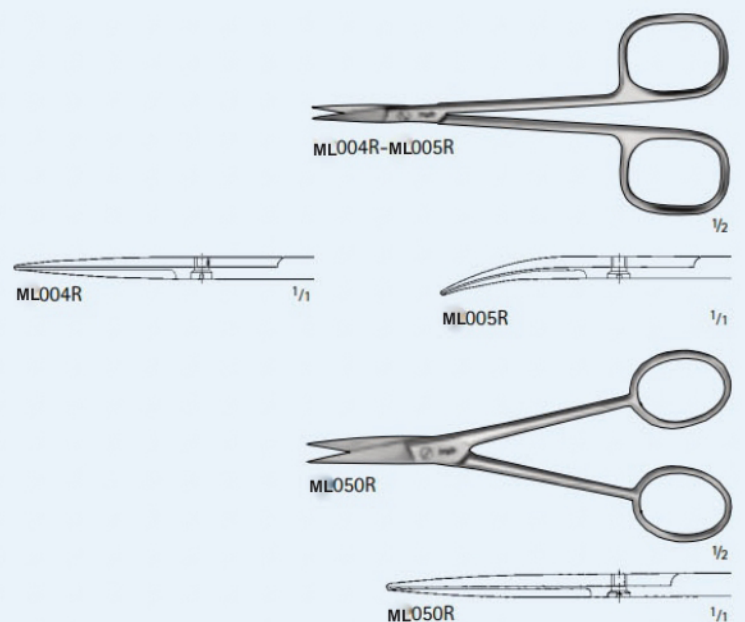

Scissors

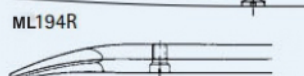
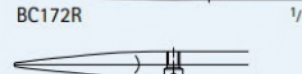
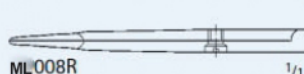
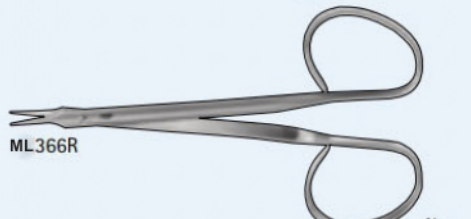
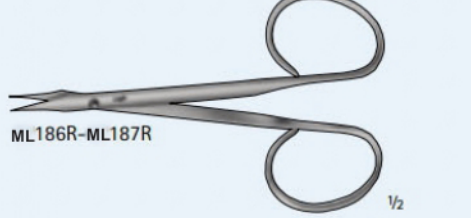
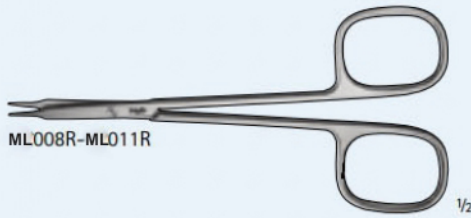

STEVENS Tenotomy Scissors

ML008R

Square Handle, Straight, Sharp/Sharp, 4 1/2"

ML009R

Square Handle, Curved, Sharp/Sharp, 4 1/2"

ML010R

Square Handle, Straight, Blunt/Blunt, 4 1/2"

ML011R

Square Handle, Curved, Blunt/Blunt, 4 1/2"

ML170R

Round Handle, Straight, Sharp/Sharp, 4 3/8"

ML171R

Round Handle, Curved, Sharp/Sharp, 4 3/8"

ML172R

Round Handle, Straight, Blunt/Blunt, 4 3/8"

ML173R

Round Handle, Curved, Blunt/Blunt, 4 3/8"

ML194R

Fine, Round Handle, Straight, Blunt/Blunt, 5"

ML195R

Fine, Round Handle, Curved, Blunt/Blunt, 5"

ML186R

Ribbon Handle, Straight, Sharp/Sharp, 4"

ML187R

Ribbon Handle, Curved, Sharp/Sharp, 4"

ML366R

Ribbon Handle, Curved, Blunt/Blunt, 4 3/8"

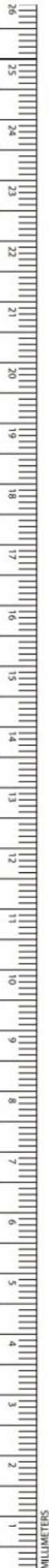

Strabismus Scissors

ML020R

Delicate, Square Handle, Straight, Blunt/Blunt, 4 1/2"



ML020R 1/1

ML021R

Delicate, Square Handle, Curved, Blunt/Blunt, 4 1/2"



ML021R 1/1

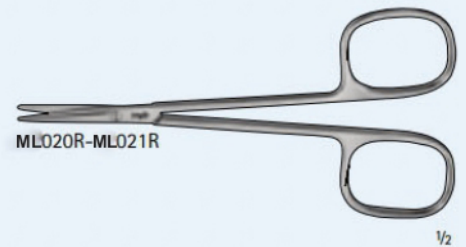

ML020R-ML021R

1/2

ML164R

Delicate, Round Handle, Straight, Blunt/Blunt, 4 1/2"



ML164R 1/1

ML165R

Delicate, Round Handle, Curved, Blunt/Blunt, 4 1/2"



ML165R 1/1



ML164R-ML165R

1/2

Iris Scissors, Durotip

ML210R

TC, Straight, Sharp/Sharp, 4 3/8"



ML210R 1/1

ML211R

TC, Curved, Sharp/Sharp, 4 3/8"



ML211R 1/1

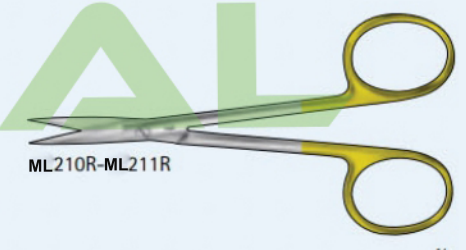

ML210R-ML211R

1/2

ML211W

TC, Serrated, Curved, Sharp/Sharp, 4 3/8"



ML211W 1/1

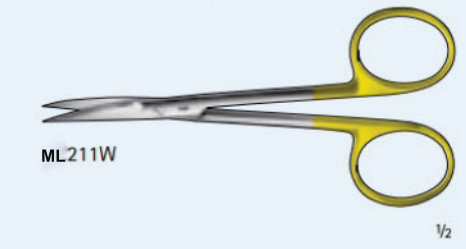

ML211W

1/2

Strabismus Scissors, Durotip

ML256R

TC, Straight, Blunt/Blunt, 4 1/2"

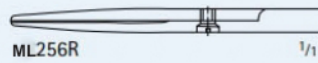

ML256R 1/1

ML257R

TC, Curved, Blunt/Blunt, 4 1/2"



ML257R 1/1

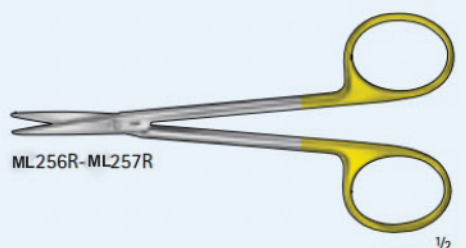

ML256R-ML257R

1/2

ML257W

TC, Serrated, Curved, Blunt/Blunt, 4 1/2"

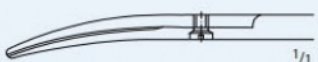

ML257W 1/1

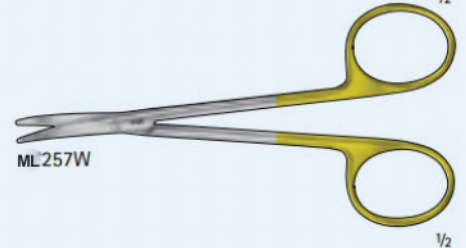

ML257W

1/2

Ophthalmic Instruments

Scissors

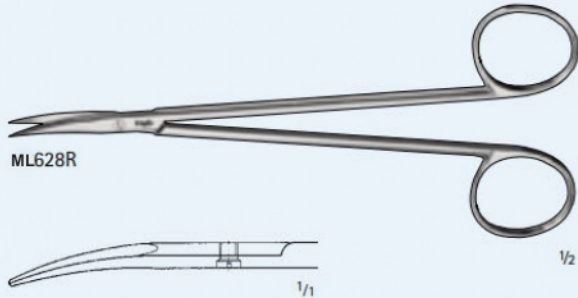

Nerve Scissors

ML628R

Curved, Sharp/Sharp, 6"

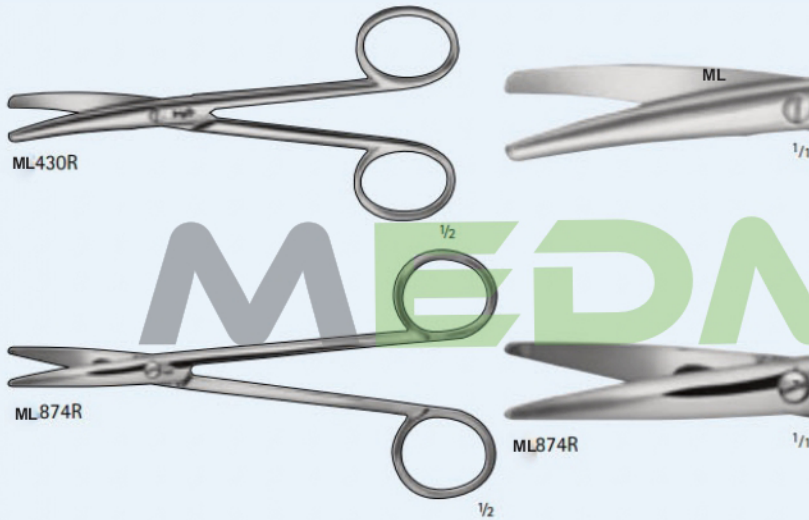

Enucleation Scissors

ML430R

Curved, 5"

ML874R

Full Curved, Heavy, 5 1/8"

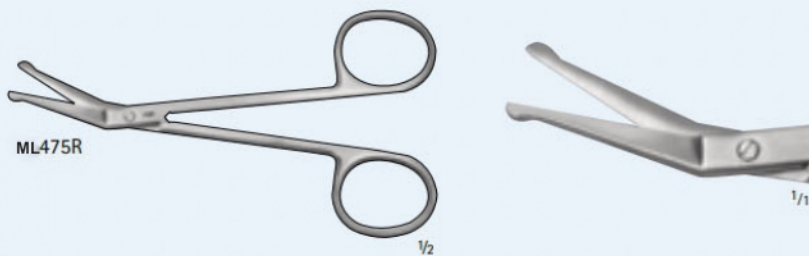

Eye Scissors

ML475R

Blunt Probe Tips, Angled, 4 1/2"

Utility Scissors

ML476R

Ribbon Handle, Straight, Blunt, 4"

ML477R

Ribbon Handle, Curved, Blunt, 4"

ML478R

Ribbon Handle, Curved, Flat, 3 7/8"



ML476R 1/1

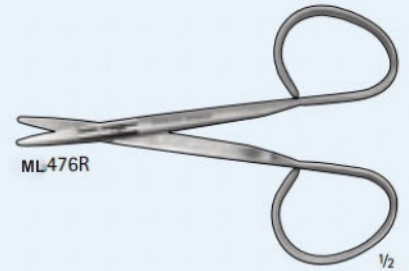

ML476R 1/2



ML477R 1/1

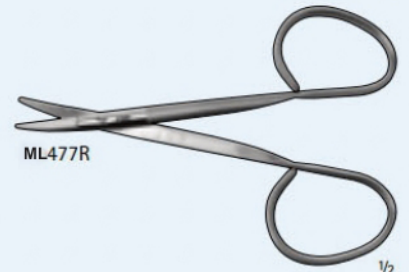

ML477R 1/2



ML478R 1/1

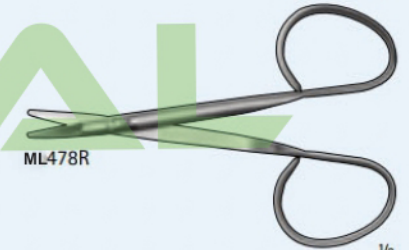

ML478R 1/2



Stitch Scissors

ML479R

Ribbon Handle, Curved, Flat, 3 3/4"



1/1

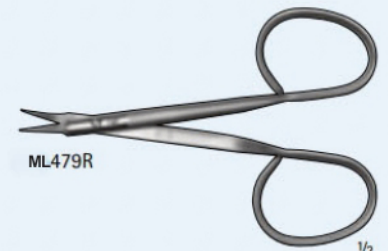

ML479R 1/2

Stitch Removal Scissors

ML480R

4 3/4"



1/1

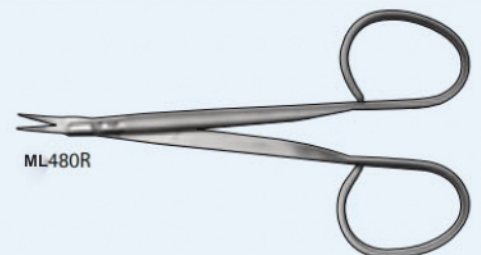

ML480R 1/2

Ophthalmic Instruments

Scissors

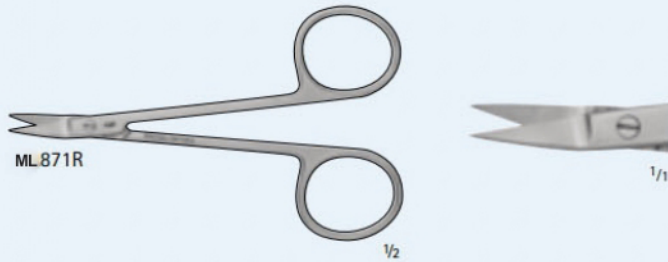

WILMER Conjunctival Scissors

ML871R

Angled-Flat, 17 mm, $4\frac{1}{8}$ "

Forceps

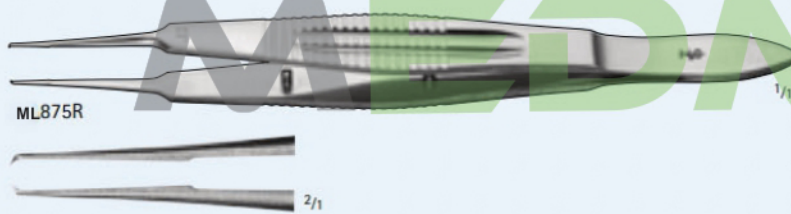

OSHER-EL SCHNIG Forceps

ML875R

1 x 2 Teeth, 3 mm x 0.12 Tying Platform, $4\frac{1}{8}$ "

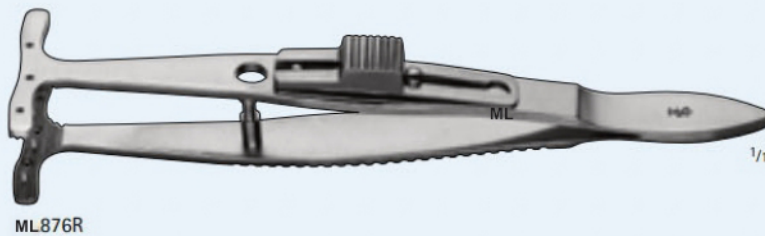

PUTTERMAN-Type Muscle Forceps

ML876R

Serrated, 6 Pins, Lock, 4"



TENNANT Tying Forceps

ML886R

Straight, Extra Delicate, Smooth Jaws, 6 mm Platform, $4\frac{1}{4}$ "



AKAHOSHI Combo Prechopper

ML888R

Straight, 4.5 mm Tips, Cross-Action, $4\frac{1}{4}$ "

SINSKEY Tying Forceps

ML885R

X-Delicate, Smooth, Curved, 4"

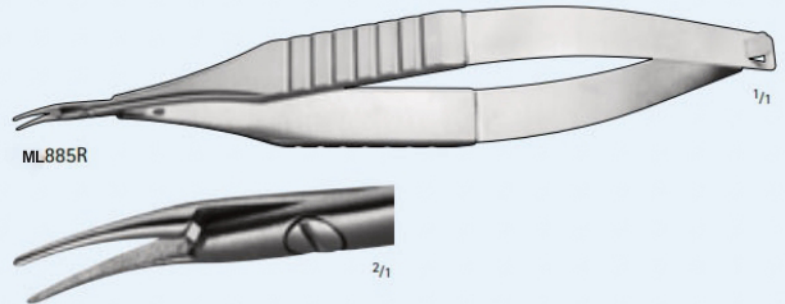

SHEPARD Lens Holding Forceps

ML891R

Curved, Duckbill Jaws, X-Action, 5"



CLAYMAN Lens Holding Forceps

ML892R

Curved, Delicate Angled Jaws, X-Action, 4 3/4"

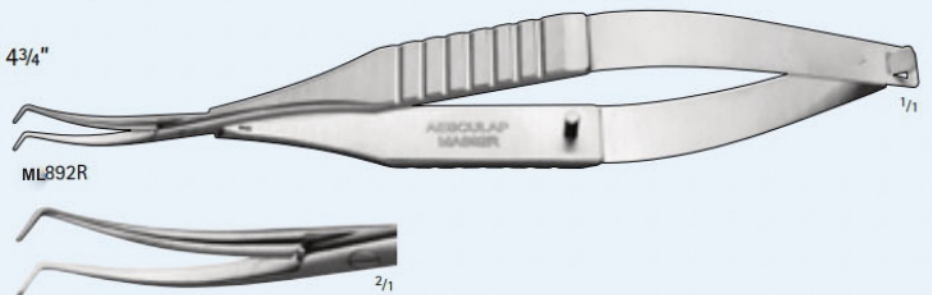

SCLERAL Plug Forceps

ML896R

Curved Angled, 9 mm Jaws, X-Action, 4 1/8"

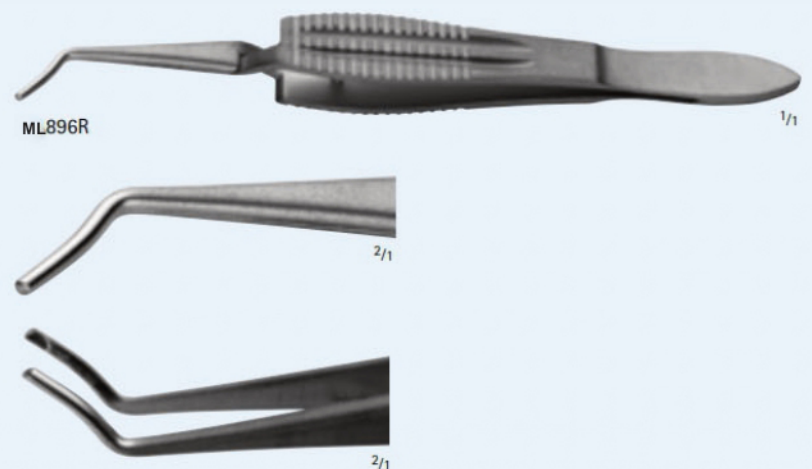

Ophthalmic Instruments

Forceps



MA898T

DEVGAN Capsulorhexis Forceps

MA898T

X-Delicate, Semi-sharp tips, 5"



MA148R - MA149R



MA150R



MA151R



MA152R



MA153R



MA154R



MA158R



MB477R



MA148R - MA149R

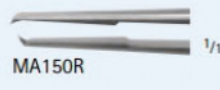

MA150R

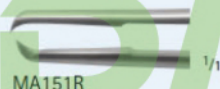

MA151R

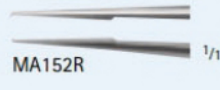

MA152R



MA153R



MA154R

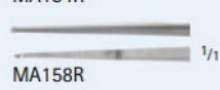

MA158R



MB477R

CASTROVIEJO Suture Forceps

MA148R

0.5 mm, 1 x 2 Teeth, with Tying Platform, Wide Handle, 4 1/4"

MA149R

1.5 mm, 1 x 2 Teeth, with Tying Platform, 4 1/4"

MA150R

0.5 mm, 1 x 2 Teeth, with Tying Platform, 4 1/4"

MA151R

0.9 mm, 1 x 2 Teeth, with Tying Platform, 4 1/4"

MA152R

0.22 mm, 1 x 2 Teeth, with Tying Platform, 4 1/4"

MA153R

0.12 mm, 1 x 2 Teeth, with Tying Platform, 4 3/8"

MA154R

0.5 mm, Angled 45° 1 x 2 Teeth, with Tying Platform, 4 1/4"

MA158R

0.3 mm Tip, 1 x 2 Teeth, with Tying Platform, 4 1/8"

MB477R

0.3 mm, 1 x 2 Teeth, with Tying Platform, Wide Handle, 4 3/8"



OC094R



CASTROVIEJO Tissue Forceps

OC094R

Delicate, 1 x 2 Teeth 0.5 mm, 4"



MA618R



CASTROVIEJO Cross Action

MA618R

10 mm from Angle to Tip, 4 1/8"

BONN Suture Forceps

ML155R
0.12 mm, 1 x 2 Teeth, Platform, 3¾"



BONN Tissue Forceps

ML878R
1 x 2 Teeth, 0.12 mm, 3"

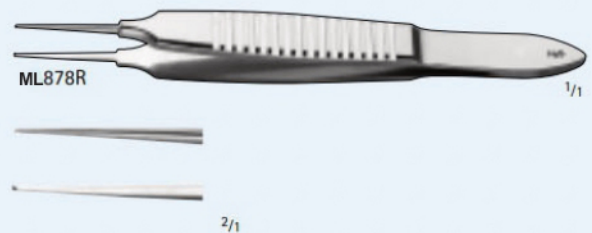

THORPE Conjunctival Fixation Forceps

ML157R
2 x 3 Teeth, 3¾"

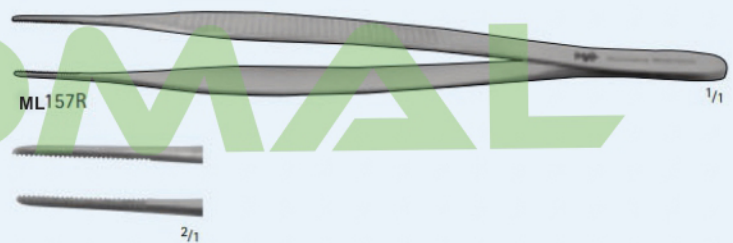

THORPE Corneal Forceps

ML901R
Straight, 45°, 0.12 mm, 2 x 3 Teeth, 3¾"



LESTER Fixation Forceps

ML166R
Fine 1 x 2 Teeth, 3¾"

ML167R
Fine 2 x 3 Teeth, 3¾"

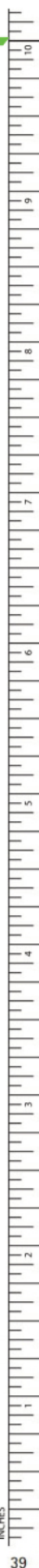
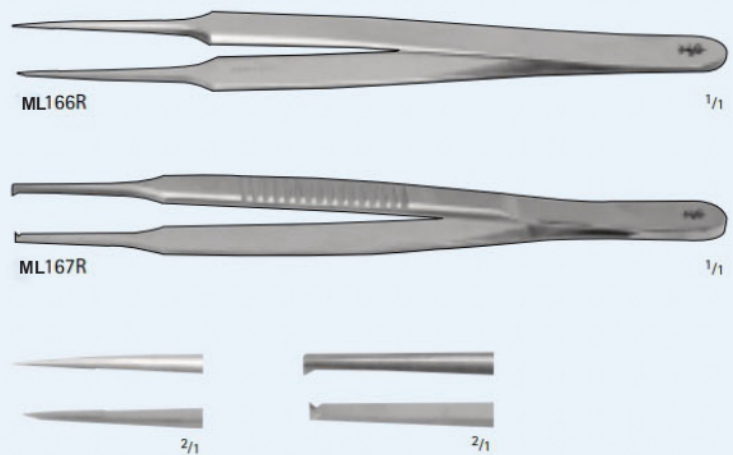

Ophthalmic Instruments

Forceps

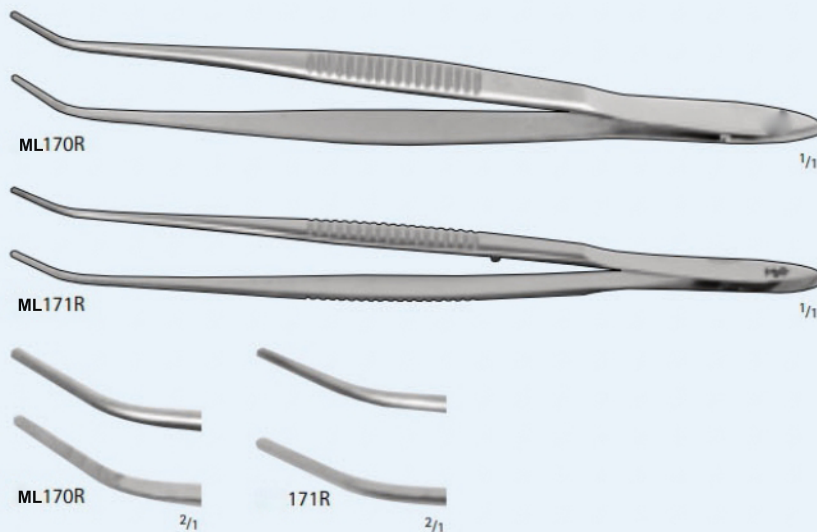

NUGENT Utility Forceps

ML170R

Serrated, Angled 45°, 10 mm Jaw, 4 1/4"

ML171R

Smooth, Angled 45°, 10 mm Jaw, 4 1/4"

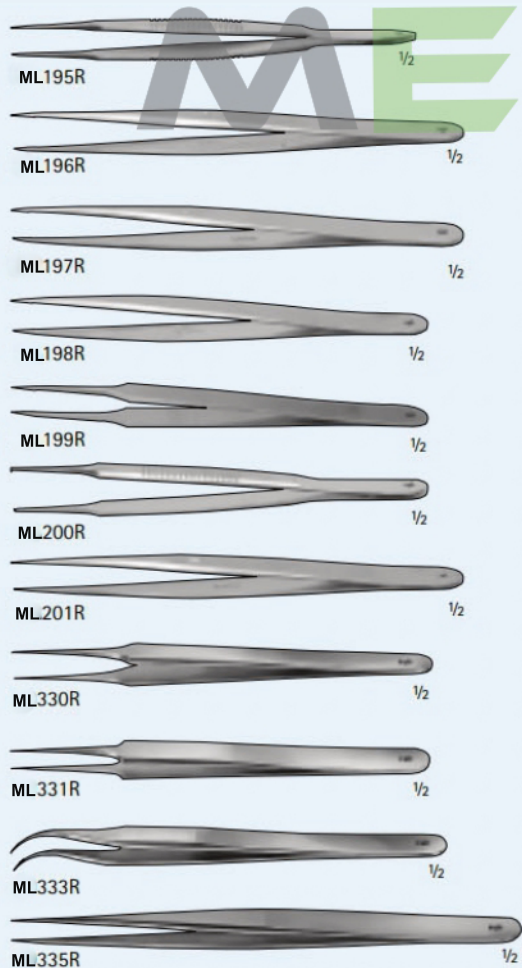

JEWELERS Micro Forceps

ML195R

3 mm Platform, 4 1/4"

ML196R

#1, Fine, 6 mm Tying Platform, 4 3/4"

ML197R

#3, Extra Fine, 5 mm Tying Platform, 4 3/4"

ML198R

#3, Extra Fine, 5 mm Tying Platform, 4 3/8"

ML199R

#4, Extra Fine, 6 mm Tying Platform, 4 3/8"

ML200R

#5, Extra Fine, 6 mm Tying Platform, 4 3/8"

ML201R

#1, Fine, 4 3/4"

ML330R

#4, 0.20 mm Tip, 4 3/8"

ML331R

#5, 0.15 mm Tip, 4 3/8"

ML333R

#7, Curved, 0.20 mm Tip, 4 3/8"

ML335R

#3, 0.30 mm Tip, 4 1/2"

BERKE Ptosis Forceps

MA316R

20 mm Jaw, 4"

MA317R

27 mm Jaw, 4 1/8"



MA316R

1/2



MA317R

1/2

Serrefine

MA548R

10 mm Serrated Jaws, 1 3/8"



MA548R

1/1

LEHNER-UTRATA Capsulotomy Forceps

MA881R

Curved, 12 mm Angled Tips, Flat Handle, 3 1/2"



MA881R

1/1



2/1

UTRATA Capsulorhexis Forceps

MA617R

12 mm Angled Tips, 3 1/8"



2/1



MA617R

1/1

CORNEAL COLIBRI Style Forceps

MA619R

1 x 2 Teeth, 50° with 6 mm Tying Platform, 4 3/16"



MA619R

1/1



2/1



2/1

TROUTMAN BARRAQUER Corneal Forceps

MA620R

0.12 mm, 1 x 2 Teeth, 2 7/8"



2/1



MA620R

1/1

Ophthalmic Instruments

Forceps



ML897T

1/1



2/1

COLIBRI Forceps

ML897T

0.12 mm, 1x2 Teeth, Titanium, 3"



ML621R

1/1



2/1

MCPHERSON Angled Corneal Suturing Forceps

ML621R

1 x 2 Teeth, Angled, 45° with 5 mm Tying Platform, 3³/₈"



ML622R

1/1



2/1

BRACKEN Curved Iris Forceps

ML622R

Curved, Cross Serrated Tips, 3⁷/₈"



ML624R

1/1



2/1

KELMAN-MCPHERSON Forceps

ML624R

Angled 45°, 8.5 mm Tying Platform, 3¹/₄"



ML625R

1/1



2/1

MCPHERSON Forceps

ML625R

Straight 5 mm Tying Platform, 3¹/₄"

MEDMAL

BECHERT-MCPHERSON Forceps

ML879R
Angled, 10 mm tips, 3 1/4"

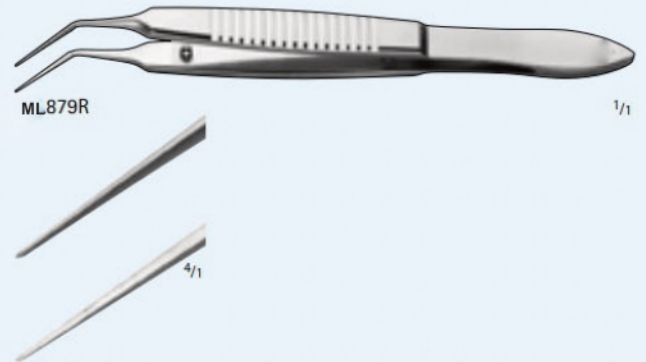

SHEETS-MCPHERSON Forceps

ML880R
Angled, 10 mm, 1 mm Cross-serrated Tips, 3 1/4"



JAMESON Muscle Forceps

ML626R
Left, 12 mm Angled Jaws, 3 3/8"

ML726R
Right, 12 mm, Angled Jaws, 4"

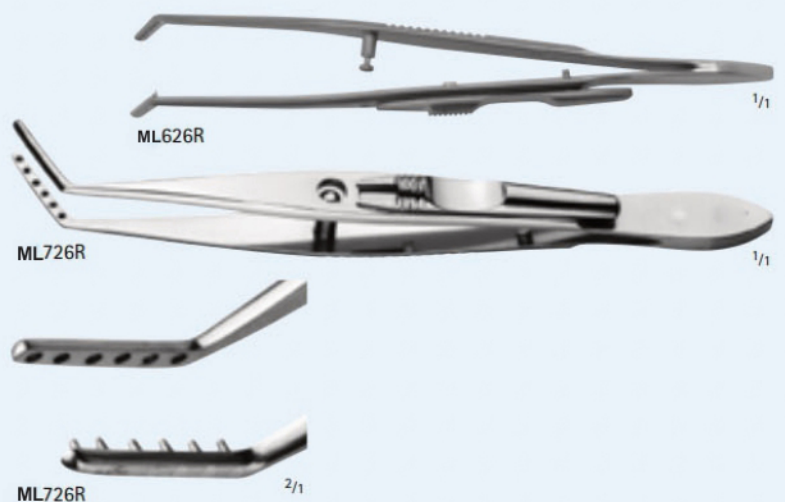

MCCULLOUGH Utility Forceps

ML623R
Smooth Jaw, Straight, 15 mm, 3 5/8"



Ophthalmic Instruments

Forceps

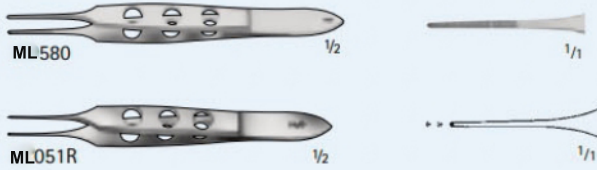

BISHOP HARMON Iris Forceps

ML580

Without Teeth, Serrated, 3 1/2"

ML051R

1 x 2 Teeth, 3 1/2"

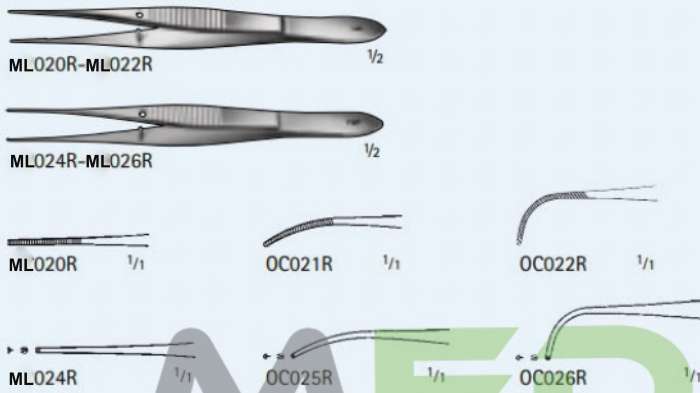

Iris Forceps

ML020R

Delicate, Serrated, Straight, 4"

ML021R

Delicate, Serrated, Curved, 4"

ML022R

Delicate, Serrated, Heavy Curved, 4"

ML024R

X-Fine, 1 x 2 Teeth, Straight, 4"

ML025R

X-Fine, 1 x 2 Teeth, Curved, 4"

ML026R

X-Fine, 1 x 2 Teeth, Heavy Curved, 4"

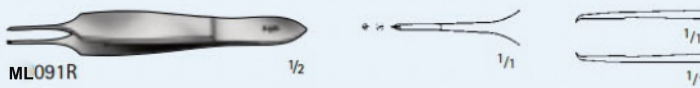

ST MARTIN Tissue Forceps

ML091R

Delicate, 1 x 2 Teeth, 3 1/8"



GRAEFE Tissue Forceps

ML100R

4 1/2"

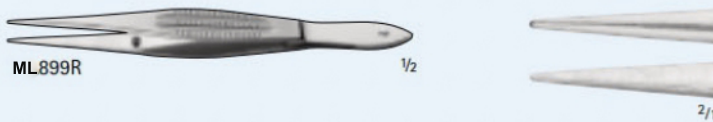

Tying Forceps

ML899R

Straight, 4 1/4"

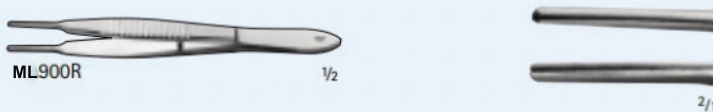

ALABAMA UNIVERSITY Forceps

ML900R

Straight, 15 mm V-Grooved Platform, 3 1/2"

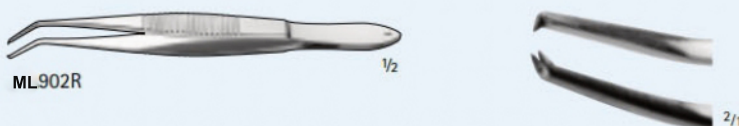

TROUTMAN Superior Rectus Forceps

ML902R

1 x 2 Teeth, 10 mm, Angled, 4 1/8"

BARRAQUER Micro Needle Holder

ML560R

Round Handle, Curved, Smooth, without Catch, 4 1/2"



ML560R 1/1

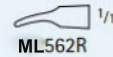

ML562R 1/1



ML560R-ML562R 1/2

ML562R

Round Handle, Curved, Delicate Smooth, without Catch, 4 3/4"



ML230R 1/1

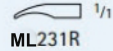

ML231R 1/1



ML230R-ML231R 1/2

ML230R

Round Handle, Straight, Smooth, without Catch, 4 3/4"



ML232R 1/1



ML233R 1/1



ML232R-ML233R 1/2

ML232R

Round Handle, Straight, Smooth, with Catch, 4 3/4"



ML351R 1/1



ML351R 1/2

ML231R

Round Handle, Curved, Smooth, without Catch, 4 3/4"

ML233R

Round Handle, Curved, Smooth, with Catch, 4 3/4"

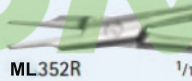

ML352R 1/1



ML352R 1/2

ML351R

Round Knurled Handle, Straight, with Catch, 5 1/4"



ML357R 1/1



ML357R 1/2

ML352R

Round Knurled Handle, Straight, without Catch, 5 1/4"

ML357R

Round Knurled Handle, Curved, without Catch, 5 3/8"



ML358R 1/1



ML358R 1/2

ML358R

Round Knurled Handle, Curved, with Catch, 5 1/4"



ML360R 1/1



ML360R 1/2

ML360R

Round Knurled Handle, Curved, without Catch, 4 1/4"

COHEN Micro Needle Holder

ML353R

Round Knurled Handle, Curved, without Catch, 4 1/8"



ML353R 1/1



ML353R 1/2

ML354R

Round Knurled Handle, Curved, with Catch, 4 1/8"



ML354R 1/1



ML354R 1/2

Ophthalmic Instruments

Needle Holders

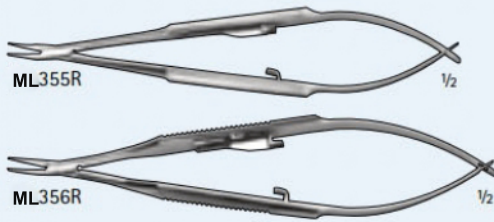

ML355R

1/2

ML356R

1/2



ML355R

2/1

ML356R

2/1

TROUTMAN Micro Needle Holder

ML355R

Flat Handle, Curved, with Catch, 4 3/4"

ML356R

Flat Handle, Curved, 9 mm Jaw, with Catch, 5 1/8"

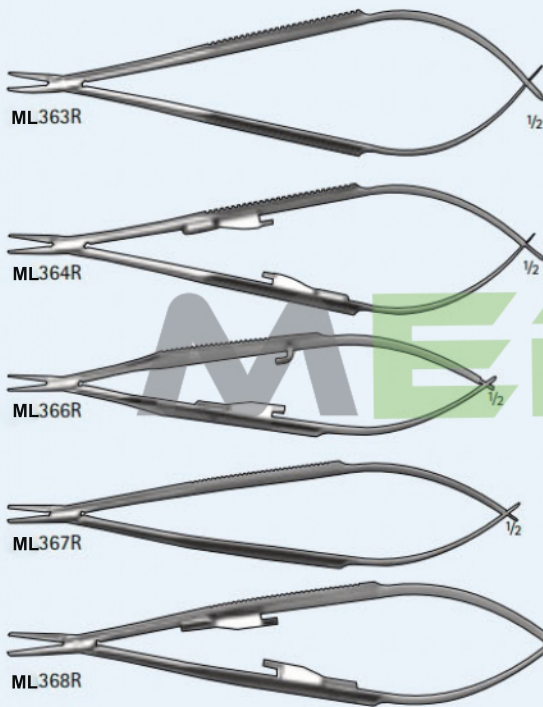

ML363R

1/2

ML364R

1/2

ML366R

1/2

ML367R

1/2

ML368R

1/2



ML363R

2/1

ML364R

2/1

ML366R

2/1

ML367R

2/1

ML368R

2/1

CASTROVIEJO Micro Needle Holder

ML363R

Flat Handle, Curved, 10 mm Jaw, without Catch, 5 5/8"

ML364R

Flat Handle, Straight, 10 mm Jaw, with Catch, 5 5/8"

ML366R

Flat Handle, Straight, 9 mm Jaw, with Catch, 5 1/8"

ML367R

Flat Handle, Straight, 10 mm Jaw, without Catch, 5 3/8"

ML368R

Flat Handle, Straight, 16 mm Jaw, with Catch, 5 7/8"

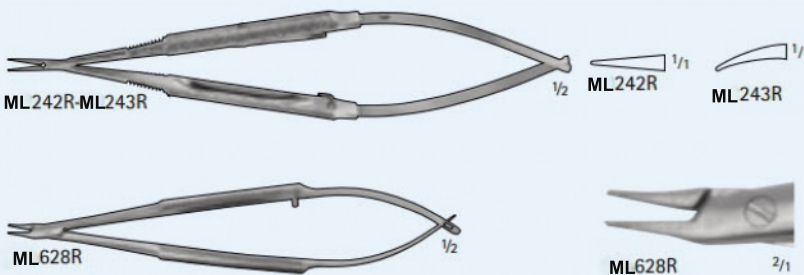

ML242R-ML243R

1/2

ML242R

1/1

ML243R

1/1

ML628R

1/2



ML628R

2/1

Micro Needle Holder

ML242R

Round Handle, Straight, Smooth, with Catch, 6"

ML243R

Round Handle, Curved, Smooth, with Catch, 6"

ML628R

Delicate Jaws Curved without Lock, Knurled Handle, 4 3/4"



ML907R

1/2



ML907R

2/1

HAMPTON Micro Needle Holder

ML907R

Heavy Jaw, Curved, with Catch, 5 1/8"

MCPHERSON Micro Needle Holder

ML908R

Flat Handle, Delicate, Straight, with Catch, 4 1/4"

ML909R

Flat Handle, Delicate, Straight, without Catch, 4 1/4"

ML910R

Flat Handle, Delicate, Curved, with Catch, 4 1/8"

ML911R

Flat Handle, Delicate, Curved, without catch, 4 1/8"



ML908R-ML909R



ML910R-ML911R



ML908R-ML909R



ML910R-ML911R

BROWN Needle Holder

ML362R

Serrated, 13 mm Jam, 5 1/4"

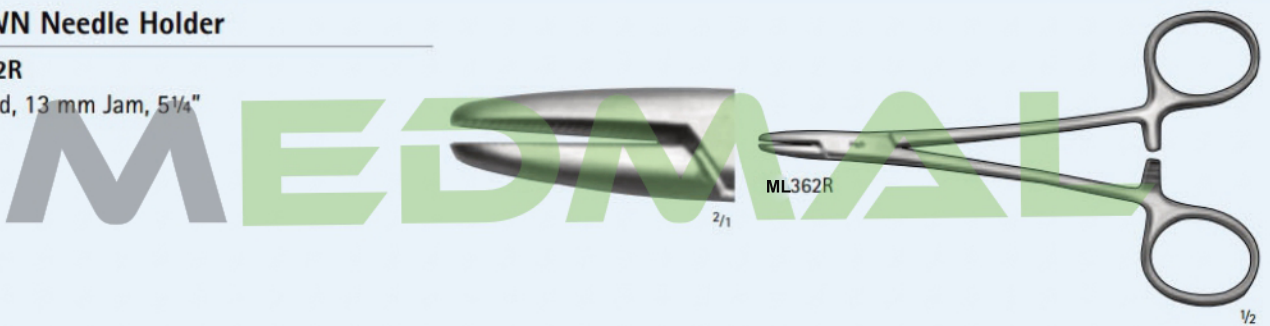

ML362R

1/2

Dilator/Lacrimal Probes

CASTROVIEJO Lacrimal Dilator

ML921R

Double Ended, Fine and Medium Taper, 4 3/4"



ML921R

1/1

RUDEMANN Lacrimal Dilator

ML917R

12 mm, 2 3/4"



ML917R

1/1

Ophthalmic Instruments

Dilator/Lacrimal Probes

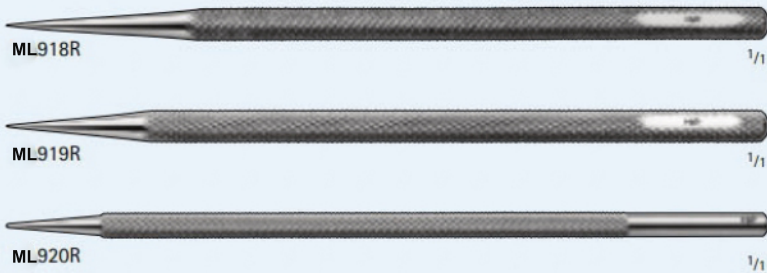

WILDER Lacrimal Dilators

ML918R
Long Taper , 23 mm, 4"

ML919R
Medium Taper , 18 mm, 4"

ML920R
Short Taper , 13 mm, 4"

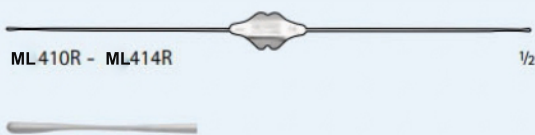

WILLIAMS Lacrimal Probes

ML410R
#00/0, 5 1/2"

ML411R
#1/2, 5 1/2"

ML412R
#3/4, 5 1/2"

ML413R
#5/6, 5 1/2"

ML414R
#7/8, 5 1/2"

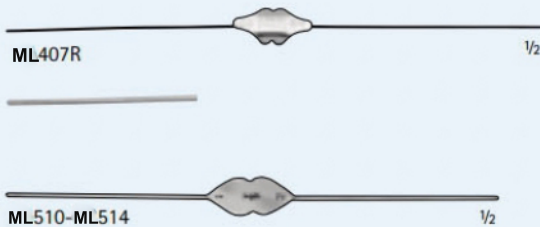

BOWMAN Lacrimal Probes

ML407R
#0000/000, 5 5/8"

ML510
00/0, 5 1/8"

ML511
1/2, 5 1/8"

ML512
3/4, 5 1/8"

ML513
5/6, 5 1/8"

ML514
7/8, 5 1/8"

MEDMAL

CATALANO Lacrimal Intubation Set

ML915R

Two 0.7 mm Probes Attached to 250 mm Long
Silicone Tubing (Single-Use)

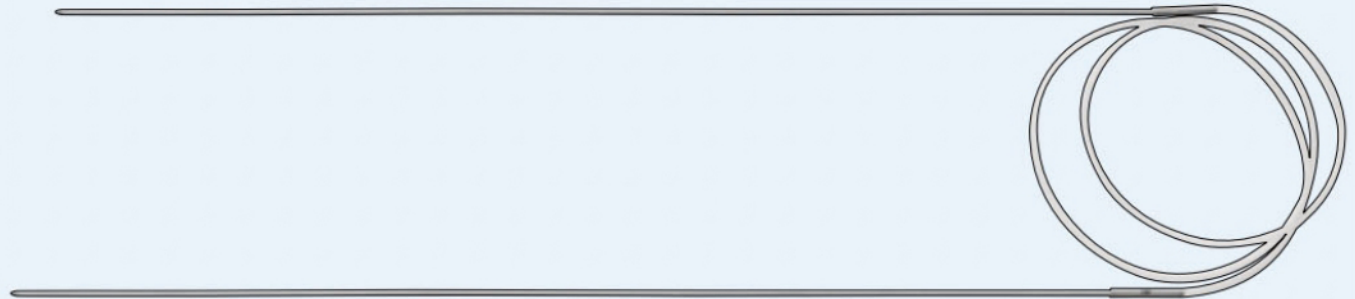

ML915R

JACKSON Lacrimal Intubation Set

ML916R

Two 0.9 mm Probes Attached to 250 mm Long
Silicone Tubing (Single-Use)



ML916R



Cannulas



CRAWFORD Lacrimal Intubation Set

ML922R

Two Olive-tipped 0.8 mm Probes Attached to
250 mm Long Silicone Tubing (Single-Use)



ML922R

MEDMAL



CRAWFORD Retrieving Hook

ML923R

For Use with MA922R, 5 1/8"

ML923R

1/1

Lacrimal Cannulas

ML925R

Straight, Reinforced, Malleable Tip, 23G, 1 3/8"



ML925R

2/1

ML926R

Curved, Reinforced, Malleable Tip, 23G, 1 3/8"



ML926R

2/1

ML959R

Straight, 23G, 1"

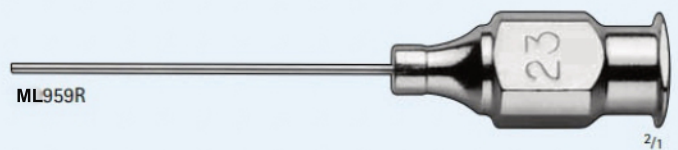

ML959R

2/1

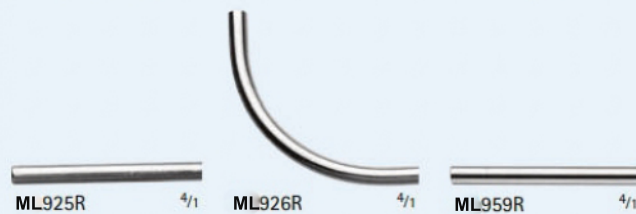

ML925R

4/1

ML926R

4/1

ML959R

4/1

SHAHINIAN Lacrimal Cannula

ML927R

Straight, Blunt Tip, 0.3 mm Side Port, 23G, 3/8"

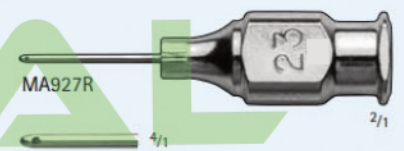

MA927R

2/1

ML927R

4/1

RANDOLPH Cyclodialysis Cannula

ML930R

Angled 13 mm from Tip, More Flattened, 19G, 1 3/8"



ML930R

4/1



ML970R

4/1

ML970R

Angled 13 mm from Tip, Flattened, 19G, 1 1/4"



ML930R

2/1



ML970R

2/1

TROUTMAN Olive Tip Cannula

ML931R

Gently Curved, 1 mm Tip, 25G, 1"



ML931R

2/1



4/1

Ophthalmic Instruments

Cannulas

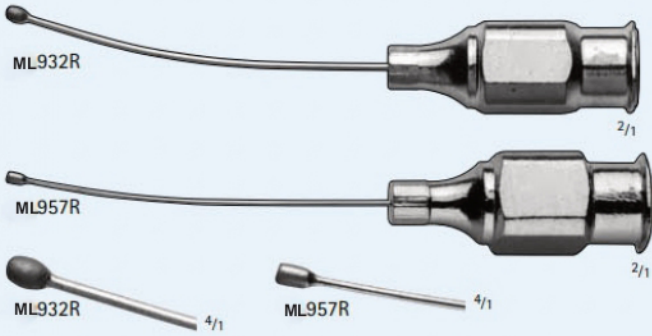

JENSEN Capsule Polisher

ML932R

Curved, Roughened Tip, Front Opening, 25G, 1"

ML957R

Curved, Roughened Tip, Front Opening, 27G, 1"



KNOLLE Capsule Polisher

ML933R

2 mm Angled Tip, Roughened, 30G, 3/4"

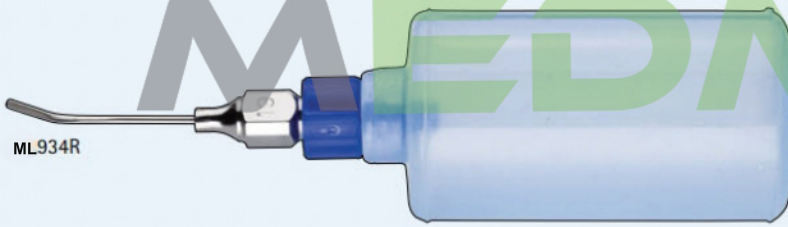

BISHOP-HARMON Anterior Chamber Irrigator Set

ML934R

Includes 19G Angled Cannula, Plastic Adaptor, Silicone Bulb

ML935

Silicone Bulb, 28 x 55 mm

ML936

Plastic Adaptor, For Use with MA935

ML937R

Cannula, Angled, 19G, 1"



Hydrodissection Cannula

ML938R

Angled, Flattened Tip, Front Opening, 25G, 3/4"



BRACKEN Irrigating Cannula

ML939R

Curved, Flattened Beveled Tip, Front Opening, 19G, 1 1/4"

SLADE LASIK Cannula

ML940R
Angled, Flattened Spatula Tip, Front Opening,
26G, 1/2"



BURATTO Cannula

ML941R
Angled, Slightly Flattened Valuted Tip, 1 Front &
2 Sides Ports, 25G, 1"

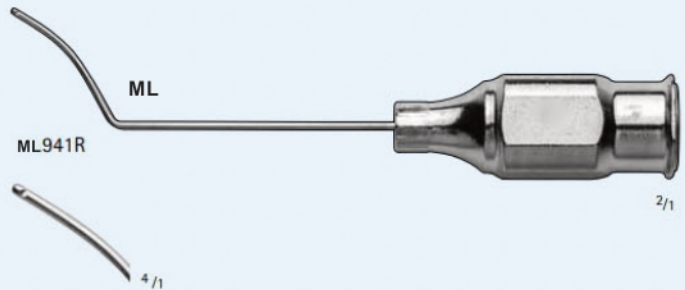

MCINTYRE Anterior Chamber Cannulas

ML942R
Angled 12 mm from Tip, Blunt Tip, 23G, 3/4"

ML943R
Angled 12 mm from Tip, Blunt Tip, 26G, 3/4"

ML944R
Angled 12 mm from Tip, Blunt Tip, 30G, 3/4"

ML962R
Straight, Blunt Tip, 23G, 3/4"

ML963R
Straight, Blunt Tip, 26G, 3/4"

ML964R
Straight, Blunt Tip, 30G, 3/4"

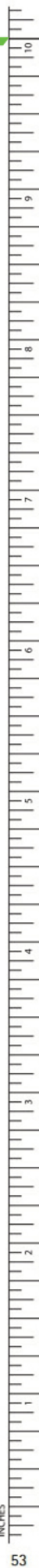
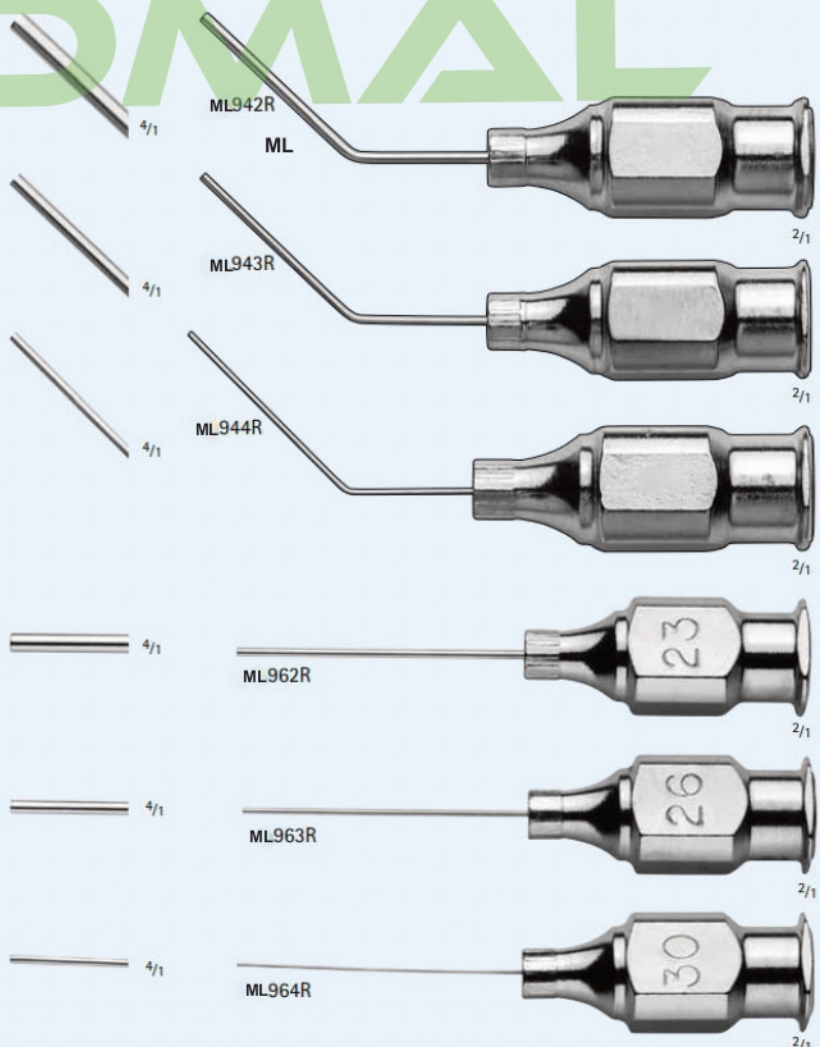

Cannulas

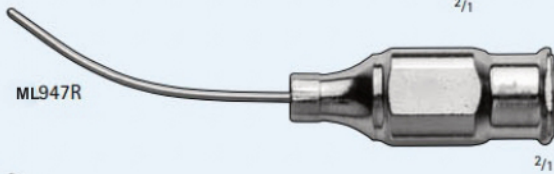
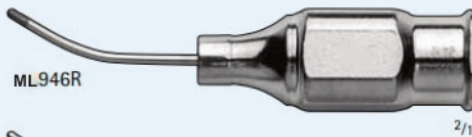
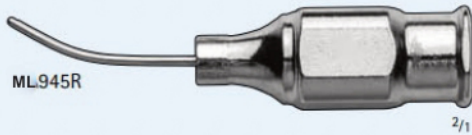

SIMCOE Cortex Extractors

ML945R
Curved, Smooth Tip, 0.3 mm Side Port, 23G, 1/2"

ML946R
Curved, Roughened Tip, 0.3 mm Side Port, 23G, 1/2"

ML947R
Curved, Smooth Tip, 0.3 mm Side Port, 23G, 3/4"

ML948R
Curved, Roughened Tip, 0.3 mm Side Port, 23G, 3/4"



MORRISON Aspirating Cannula

ML949R
Angled 7 mm from Tip, Smooth Blunt Tip, Front Opening, 23G

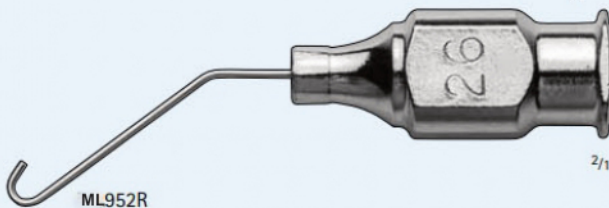
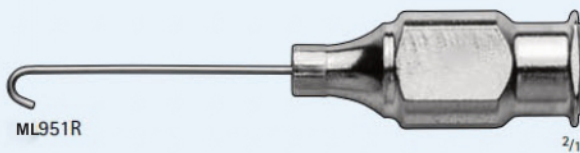
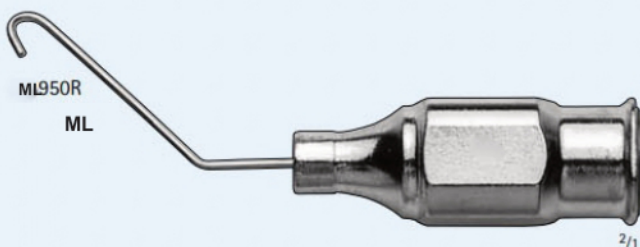

MCINTYRE-BINKHORST Cannulas

ML950R
Straight, Smooth Blunt Hook-Shaped Tip, Front Opening, 26G, 3/4"

ML951R
Right Angled, Smooth Blunt Hook-Shaped Tip, Front Opening, 26G, 3/4"

ML952R
Left Angled, Smooth Blunt Hook-Shaped Tip, Front Opening, 26G, 3/4"

**CHANG Nucleus Hydrodissector
Cannula**

ML953R
Angled 900, Flat Tip, Beveled Opening, 27G, 1/2"

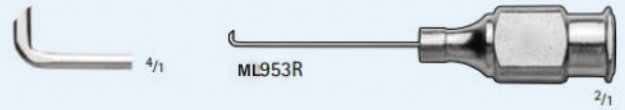

ATKINSON Retrobulbar Needle

ML954R
23G, 1 3/8"



KELMAN Cystotome

ML955R
22G, 1 1/4"



KRATZ Capsule Scrubber

ML956R
Angled, Roughened, 23G, 3/4"

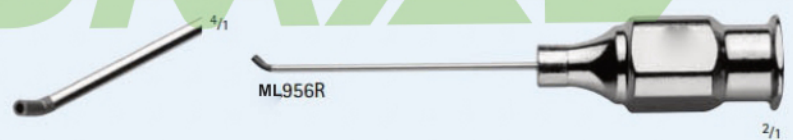

Backflush Infusion Cannula

ML958R
23G, 1 3/8"



NICHAMIN Hydrodissection Cannula

ML960R
25G



Ophthalmic Instruments

Cannulas

SIMCOE Irrigating Aspirating Unit

ML965R

23G, Apiration Through 0.3 mm Top Port,
Irrigation Through Front Port, uses 225 mm
Tubing

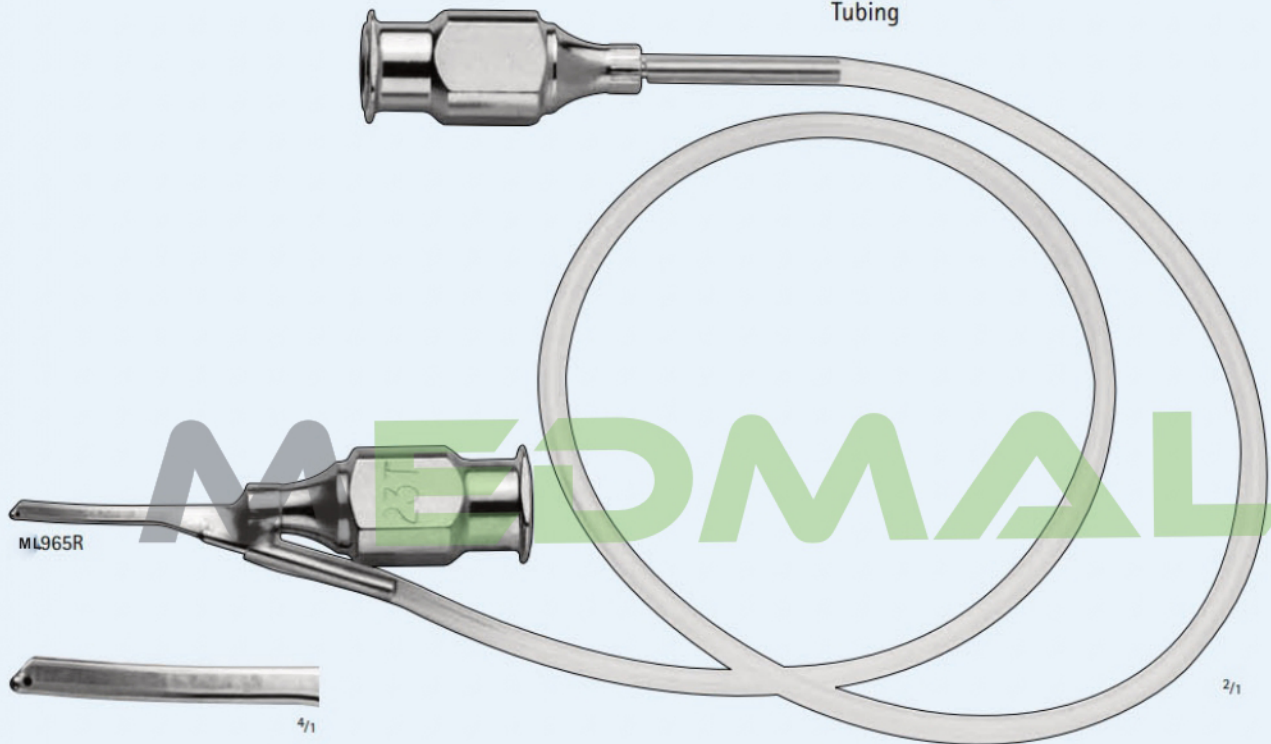

WEST LACRIMAL CANNULA

968R

0.3 mm Side Port, 23G, 1 1/4"



Air Injection Cannulas

ML640R

27 Gauge, Angled Tip, 5 mm Tip to Bend, 3/4"

ML641R

30 Gauge, Angled Tip, 5 mm Tip to Bend, 3/4"

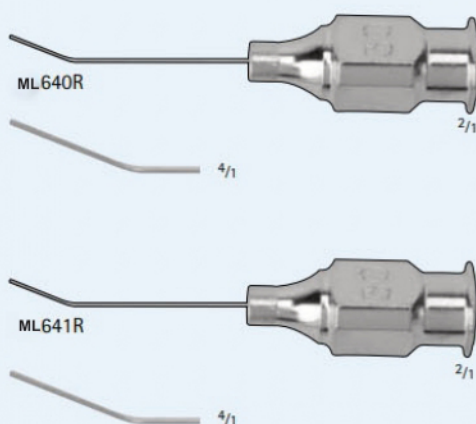

Corneal Dissector Knife

ML767R
Angled Blade, Curved Tip, 4 1/2"

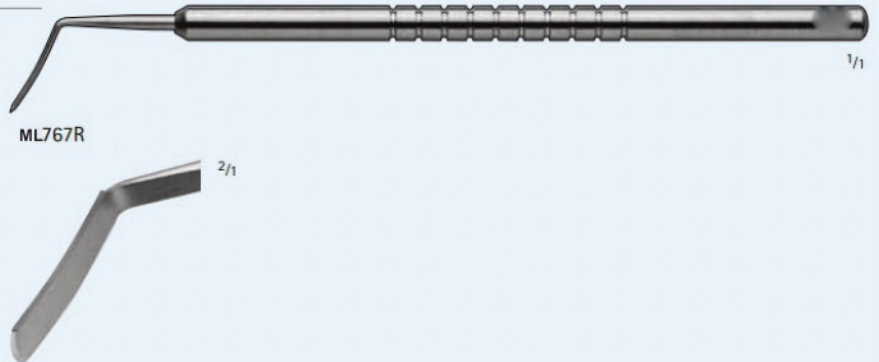

TOOKE Corneal Knife

ML773R
Straight, 3 mm x 18 mm Blade, Curved Cutting Edge, 4 3/4"



KELLY DESCOMET'S Membrane Punch

ML771R
1 mm Diameter Tip, 5 1/8"



CARTER Sphere Introducer

ML974R
5"

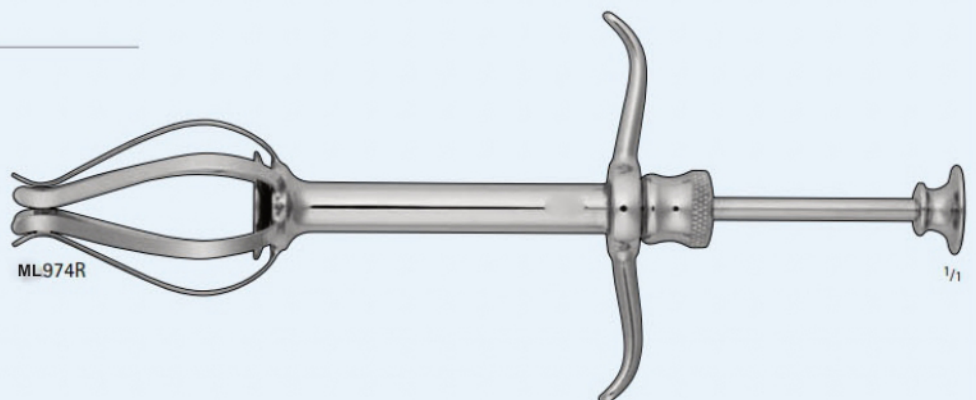

Ophthalmic Instruments

CHOPPERS



ML-9796



ML-9796



ML-9796



ML-9796

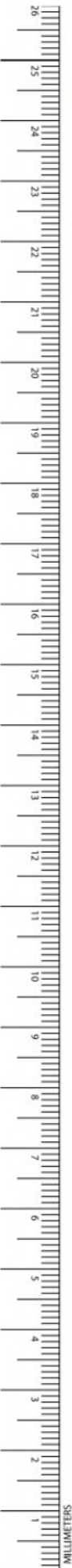

SPATULAS

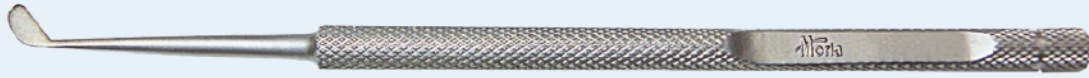

ML-9796



ML-9796

MEDMAL

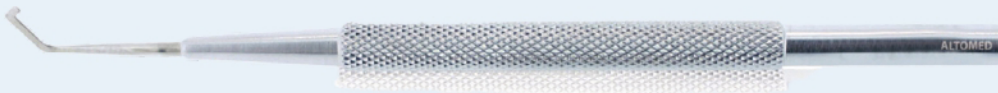

ML-9796



ML-9796

DOUBLE ENDED INSTRUMENTS



ML-9796



ML-9796

MEDMAL



ML-9796

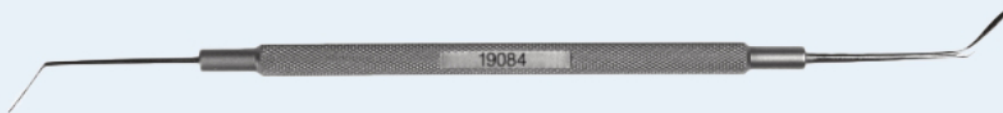

ML-9796

GAUGES

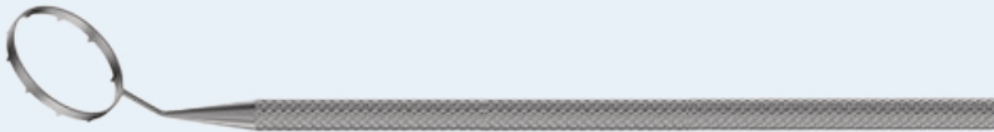

ML-9796



ML-9796

MEDMAL



ML-9796



ML-9796

CURETTES



ML-9796

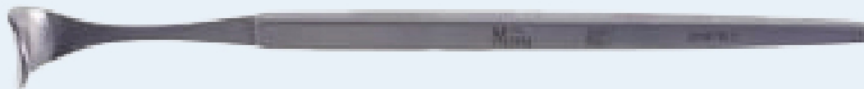

ML-9796

MEDMAL



ML-9796



ML-9796

RETRACTORS



ML-9796



ML-9796

MEDMAL

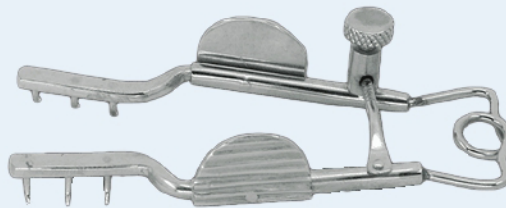

ML-9796

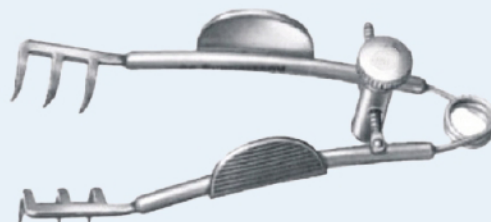

ML-9796

MEDMAL

SURGICAL INSTRUMENTS

<http://medmalsurgicalinstruments.com>

Medmal is a leading manufacturer of high-quality eye instruments, specializing in precision tools for ophthalmic diagnostics and surgery. Known for innovation and reliability, our products support healthcare professionals in delivering the best vision care and outcomes.



 03484273720

 03467702300